

4-2 BEAMS | 1695–2690 MHz, 698–960 MHz | 4T4R

Lens Technology Enabled™ Multi-Beam Cylindrical Base-Station Lens Antenna:

- Utilizes a patented cylindrical lens design
- Low Band: 2 isolated cross-polarized beams
- Mid Band: 4 isolated cross-polarized beams
- 120° coverage with the highest beam stability
- Low Band: 4x4 MIMO capability per beam
- Mid Band: 4x4 MIMO capability per beam
- Low Band Tilt: RET AISG 2.0, independent tilt per beam from 2° to 20°
- Mid Band Tilt: RET AISG 2.0, independent tilt per beam from 2° to 15°
- No beam squinting as compared to Butler matrix antennas
- Low sidelobes for all beam tilts
- Excellent Front-to-Back and CPR performance
- High-capacity solution for macro network
- Rugged mechanical design

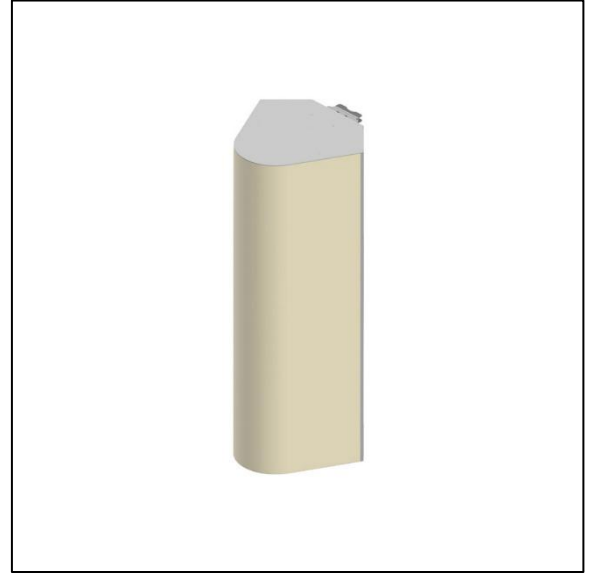

ELECTRICAL SPECIFICATIONS, BASTA

FREQUENCY, MHZ	1695-1880	1850-1990	1920-2170	2300-2400	2490-2690	698-900	790-960
GAIN, BY ALL TILTS/PORTS, DBI	19+/-0.5	19.8+/-0.5	20.3+/-0.5	21+/-0.5	21.3+/-0.5	14.6+/-1.5	15.5+/-1
VSWR	1.5:1	1.5:1	1.5:1	1.5:1	1.5:1	1.5:1	
HORIZONTAL COVERAGE, DEG	120	120	120	120	120	120	
HORIZONTAL BEAM CENTERS, DEG	-45±1.5; -15±1.5; 15±1.5; 45±1.5					-30+/-2; 30+/-2	
HORIZONTAL BEAMWIDTH, DEG	20±1	19±1	18.5±1	16.3±1	16.5±1	34±5	33±4
BEAM CROSSOVER, DB	7	8	9	11	13	10	11
HORIZONTAL SIDELOBE, DB	-17.5	-17	-15.5	-17	-17	-15.5	-15
FRONT-TO-BACK RATIO TOTAL POWER AT 180±30°, DB	30	30	30	30	30	25	27
CPR AT BORESIGHT, DB	23	22	20	20	18	14	13
CPR AT 10DB BEAMWIDTH, DB	14	13	10	10	9	12	13
REMOTE ELECTRICAL BEAM TILT, DEG	2 - 15					2 - 20	
VERTICAL BEAMWIDTH, DEG	13.5±1	13±0.7	12±0.7	10.5±0.5	9±1	23	21
USLS, BEAMPEAK TO 20° ABOVE BEAMPEAK, DB	17	18	16	15	16	N/A	N/A
ISOLATION PORT TO PORT, POLARIZATION, DB	26	26	26	26	26	26	26
ISOLATION PORT TO PORT, BEAM, DB	24	24	24	24	24	24	24
PIM, 3 RD ORDER, 2X20W, DBC	-153					-153	
MAX. POWER PER PORT, W	150					250	

ELECTRICAL SPECIFICATIONS

IMPEDANCE	50 Ohm
OPERATING FREQUENCY BAND	1695-2690MHz 698-960MHz
POLARIZATION	$\pm 45^\circ$
NUMBER OF BEAMS	4+2
NUMBER OF PORTS PER BEAM	4
CONNECTOR QUANTITY AND TYPE	24 x 4.3-10 female
TOTAL POWER, MAX	2000W

PATTERN RESULTS | L BAND

Horizontal Patterns

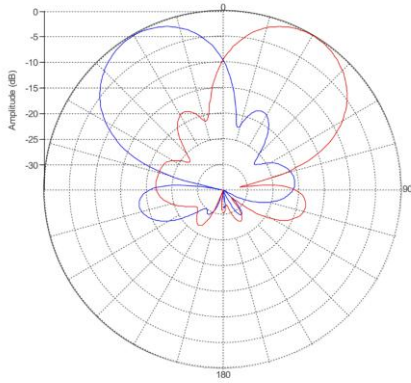

800MHz

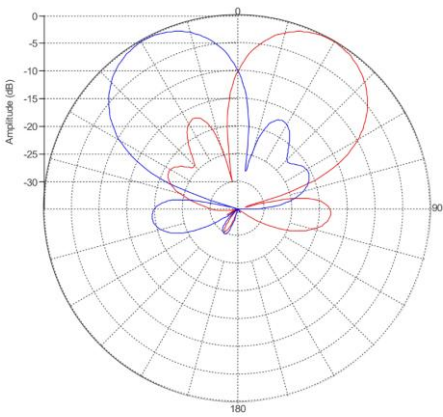

850MHz

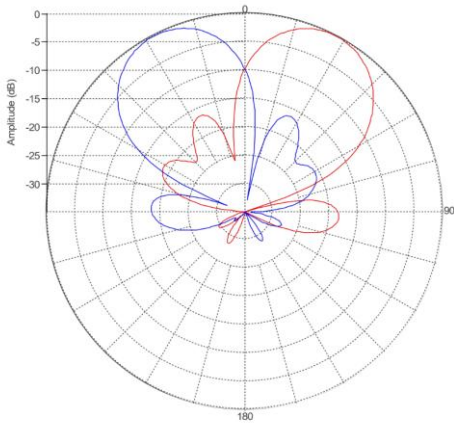

900MHz

Vertical Patterns (2°, 20°)

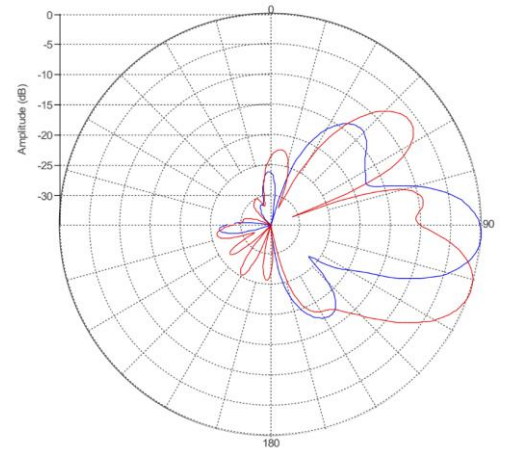
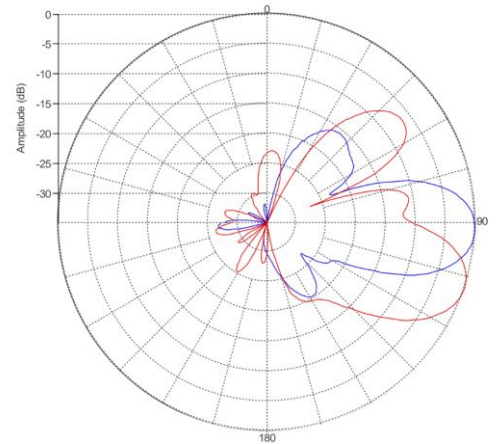
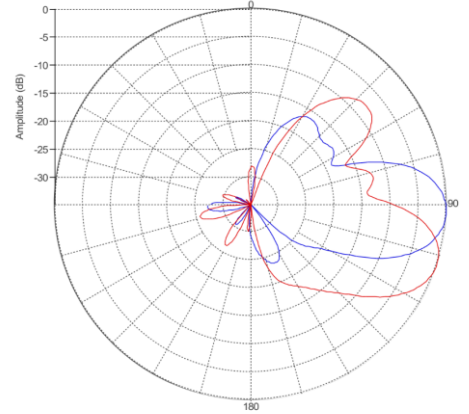

PATTERN RESULTS | H BAND

Horizontal Patterns

Vertical Patterns (2°, 15°)

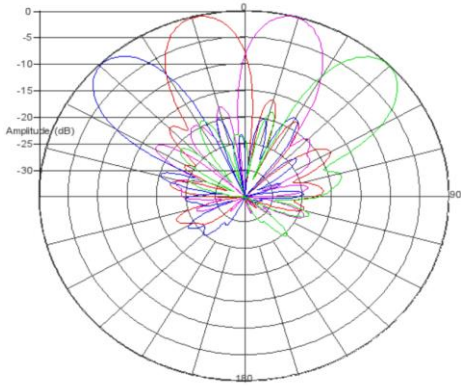

1.80GHz

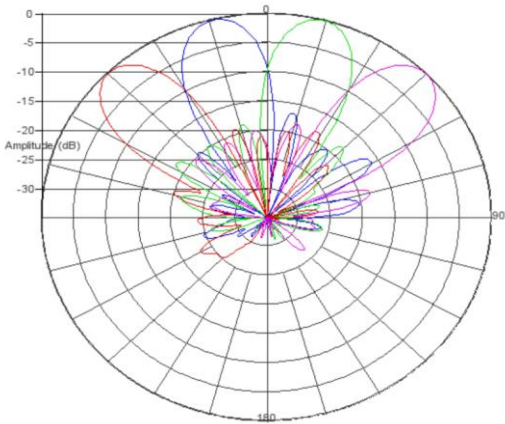
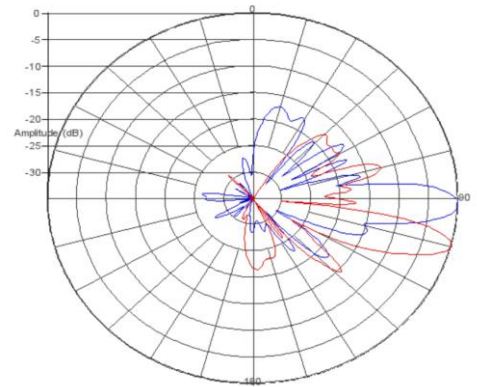

2.1GHz

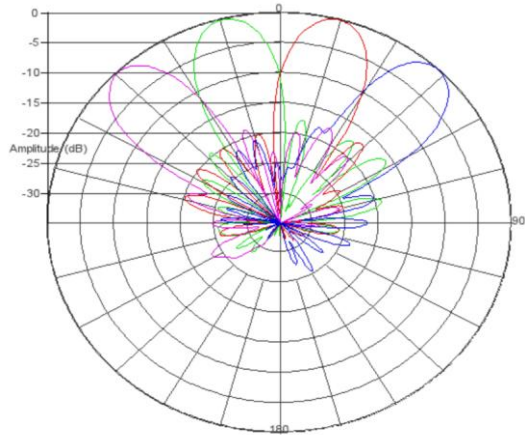
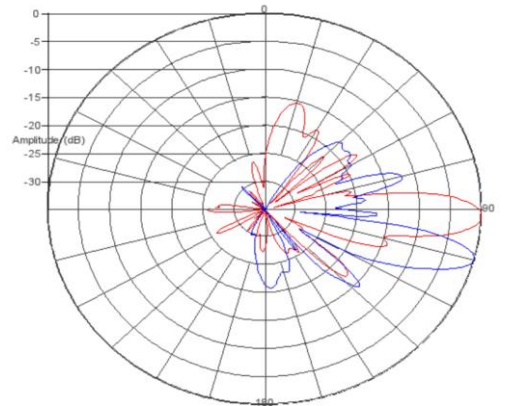

2.6GHz

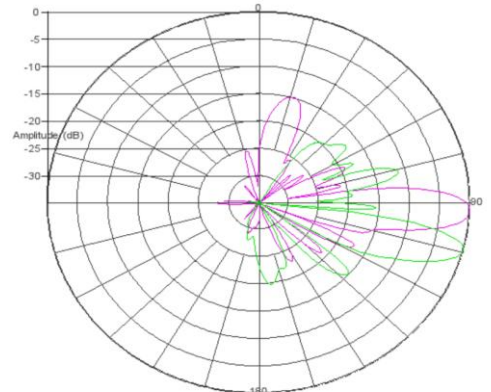

MECHANICAL SPECIFICATIONS

ANTENNA WEIGHT (WITHOUT BRACKET)	147.8 lbs	67.02 kg
BRACKET WEIGHT	4.59 lbs	2.08 kg
ANTENNA WEIGHT (WITH BRACKET)	152 lbs	69.1 kg
HEIGHT	67 in	170.1 cm
WIDTH	30.4 in	77.2 cm
DEPTH	27 in	68.5 cm
RADOME MATERIAL	Fiberglass	
RADOME COLOR	RAL 7005	
WIND LOADING @150KM/HR FRONTAL	966 N	217.2 lbf
WIND LOADING @150KM/HR LATERAL	1192 N	268 lbf
WIND LOADING @150KM/HR REAR	1117 N	251.1 lbf

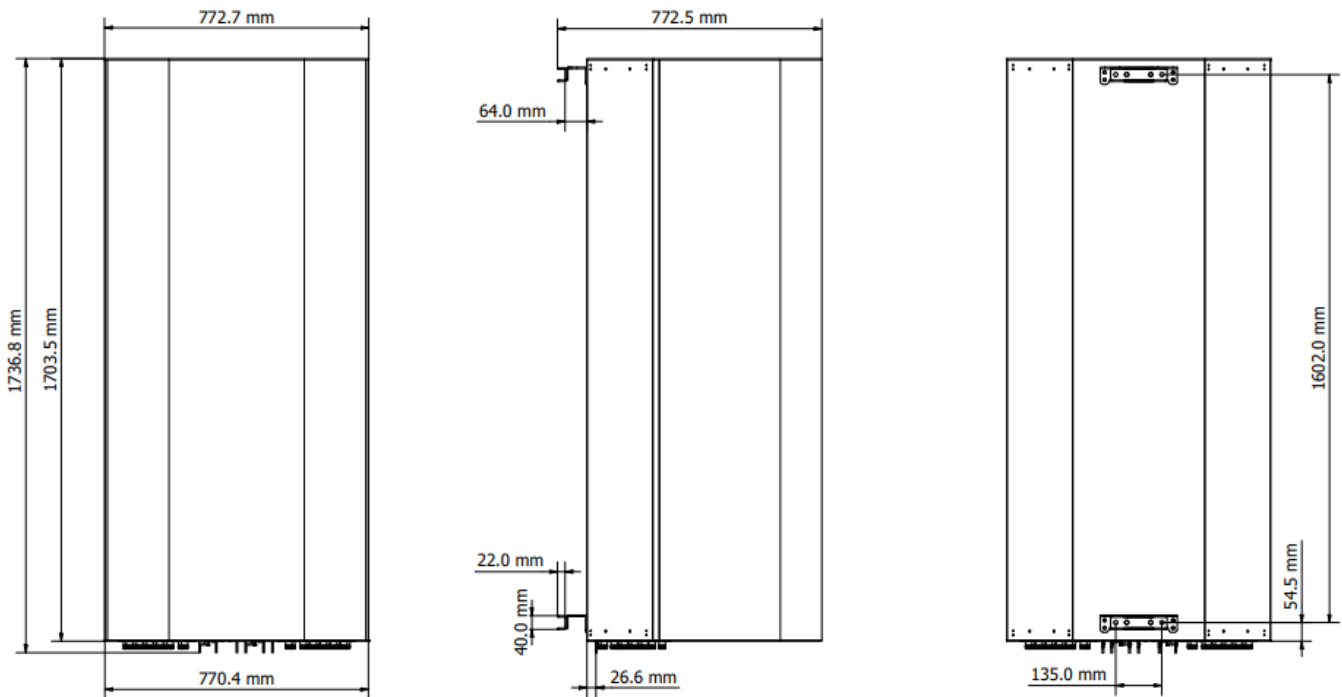

ENVIRONMENTAL RATINGS

HUMIDITY	95% RH @ +30°C
TEMPERATURE	-40°C to +70°C

BEAM, PORT, RF CONNECTOR & RET LAYOUT

HB 4		HB 3		LB 2		
Port 13 (+45°)	Port 14 (-45°)	Port 9 (+45°)	Port 10 (-45°)	Port 24 (-45°)	Port 21 (+45°)	Port 22 (-45°)
Port 15 (+45°)	Port 16 (-45°)	Port 11 (+45°)	Port 12 (-45°)	Port 23 (+45°)		

LB 1			HB 2		HB 1	
Port 19 (+45°)	Port 20 (-45°)	Port 18 (-45°)	Port 5 (+45°)	Port 6 (-45°)	Port 1 (+45°)	Port 2 (-45°)
		Port 17 (+45°)	Port 7 (+45°)	Port 8 (-45°)	Port 3 (+45°)	Port 4 (-45°)

Connector Port Table

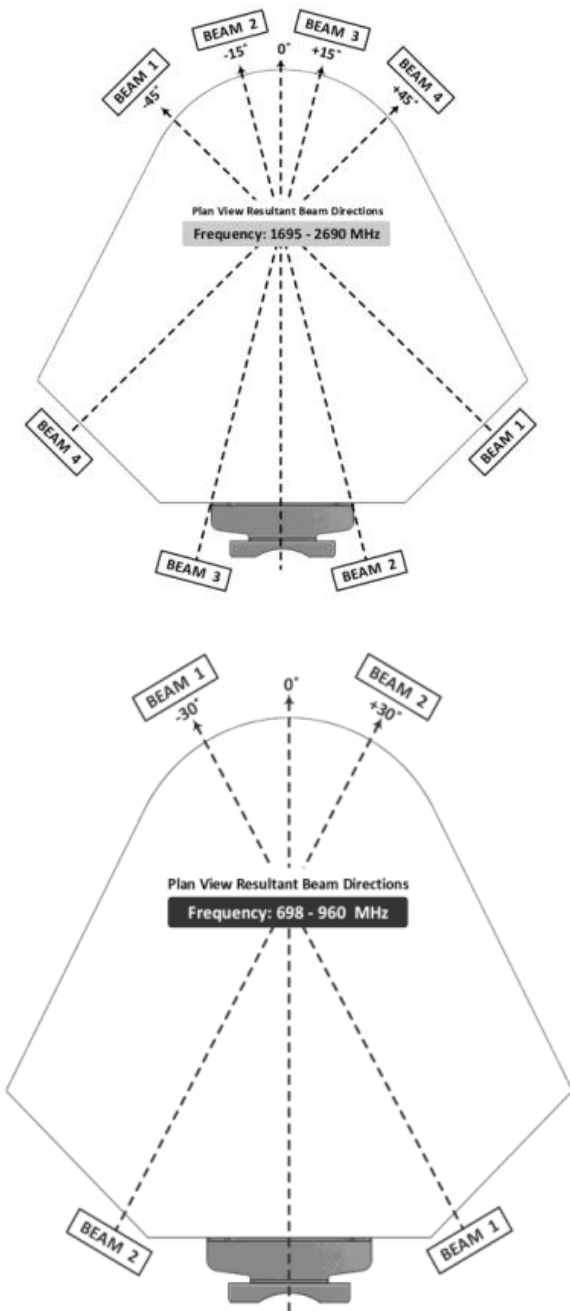

Antenna top view

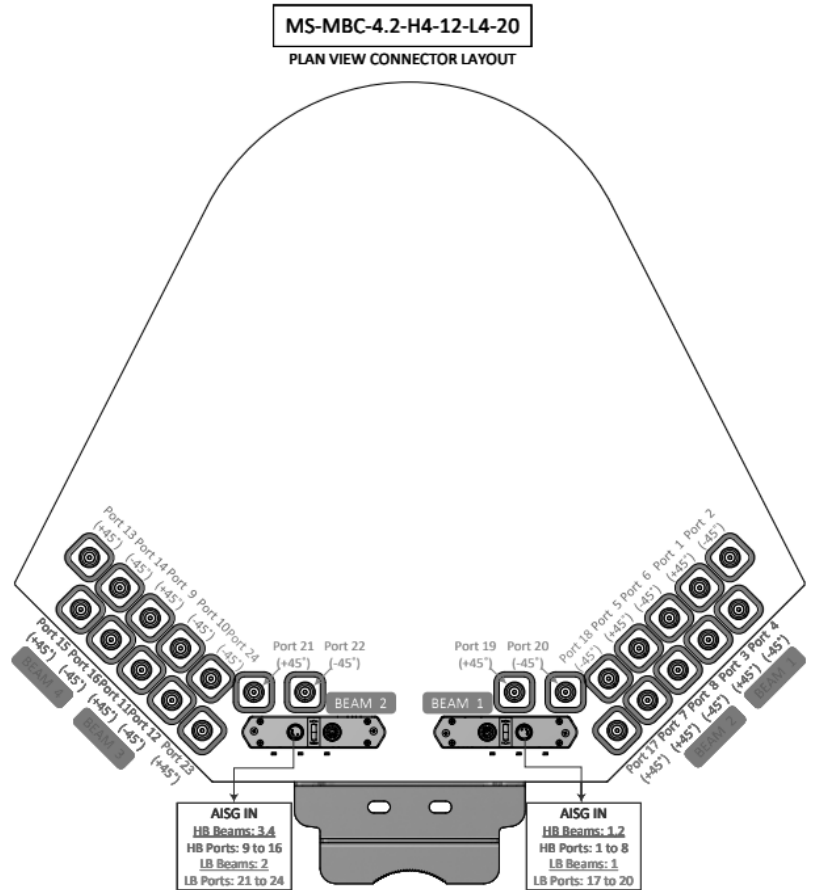

MOUNTING

COMPATIBLE PIPE DIAMETER	2.4 – 4.5 in	6.1 – 11.4 cm
BRACKET WEIGHT	4.59 lb.	2.08 kg

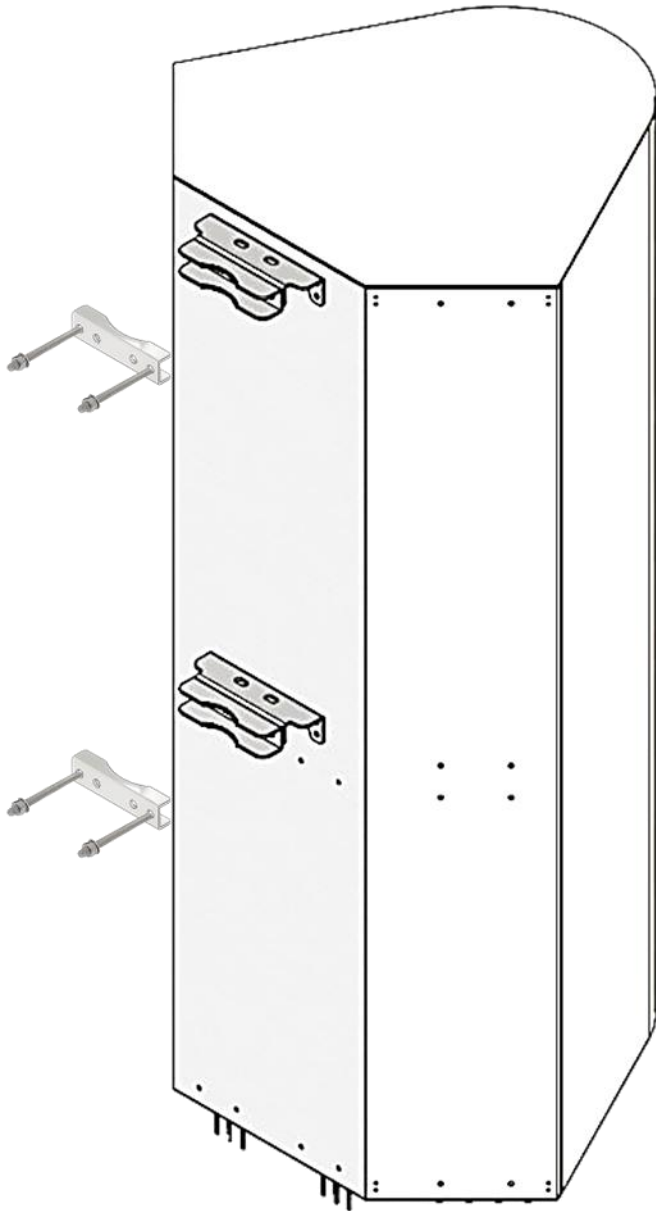

Before Installation

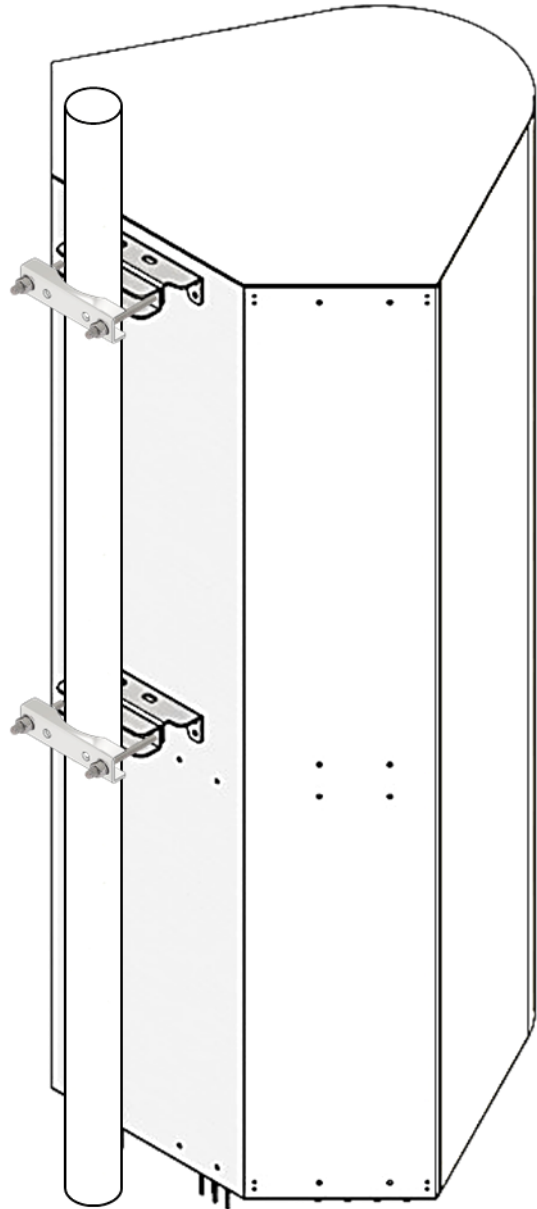

After Installation

REVISION HISTORY

DATE	DOCUMENT	
11202025	Initial BASTA Datasheet Released	