

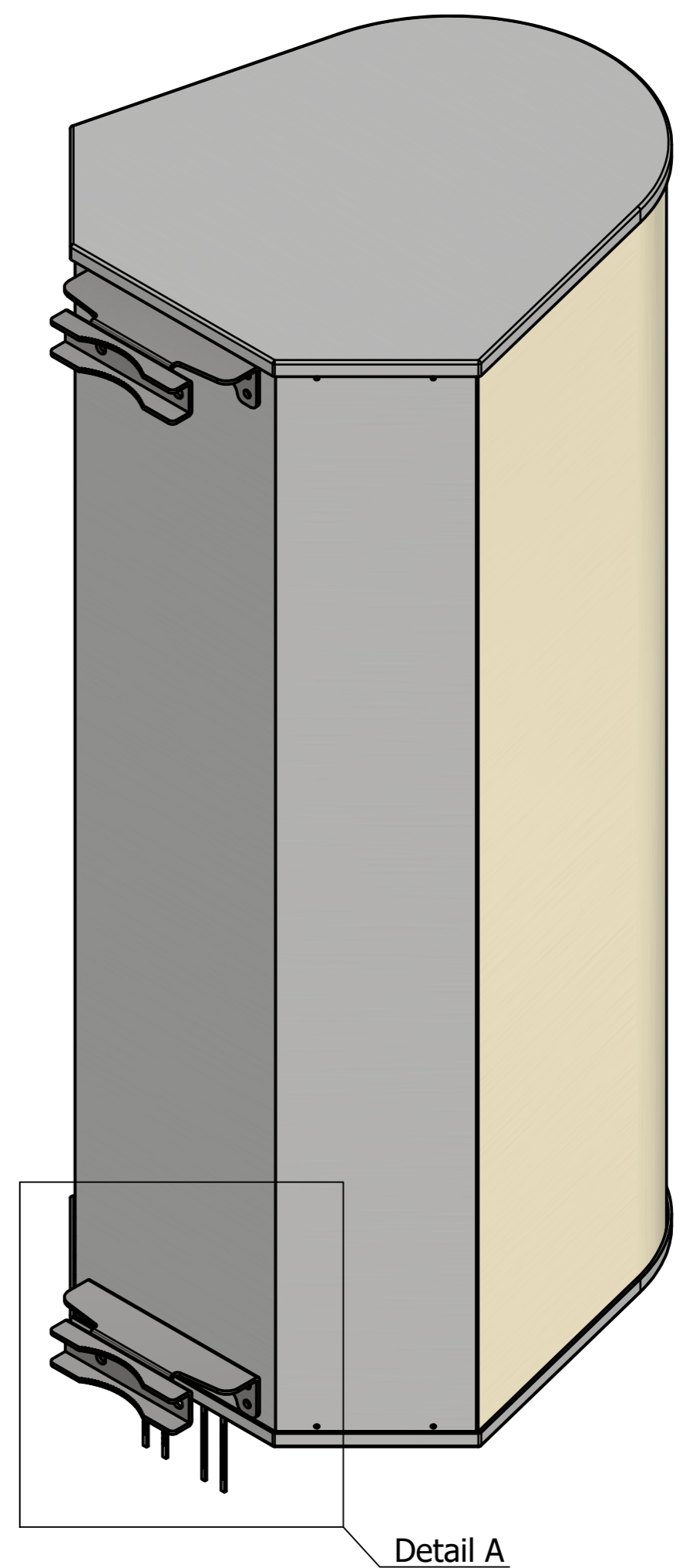

Designed by	Drawing by	Date	Approved by	Date	Quantity	Material
ALEXANDRE	LAWRENCE	19/6/2024	PAVEL	19/6/2024		
MATSING LENS TECHNOLOGY ENABLED						MS-MBC-4-H4-12
						MS-MBC-4-H4-12 (mm)
					Revision	Sheet
					1.0	1 / 3

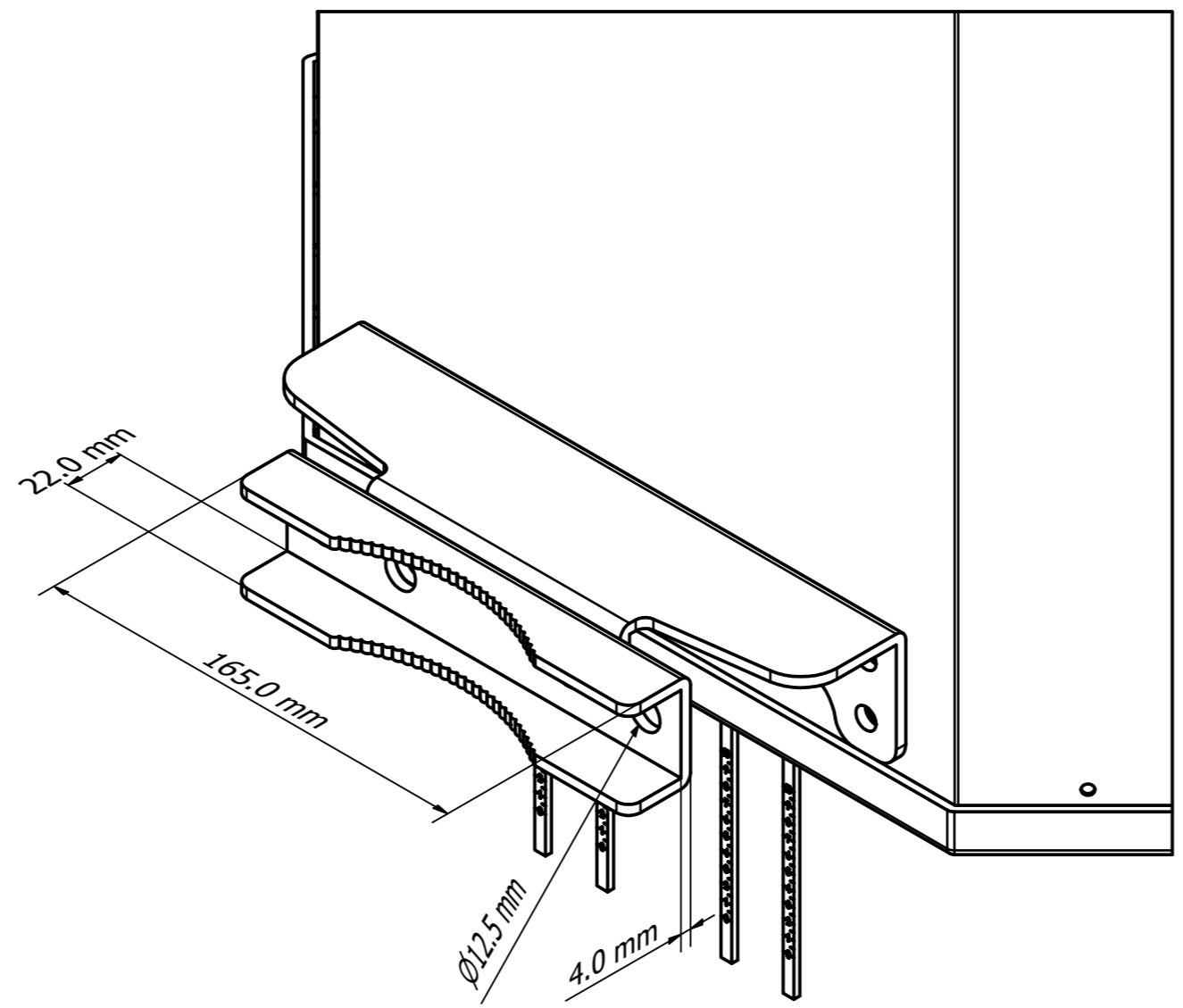

Designed by ALEXANDRE	Drawing by LAWRENCE	Date 19/6/2024	Approved by PAVEL	Date 19/6/2024	Quantity	Material
			MS-MBC-4-H4-12			
			MS-MBC-4-H4-12 (mm)	Revision 1.0	Sheet 2 / 3	

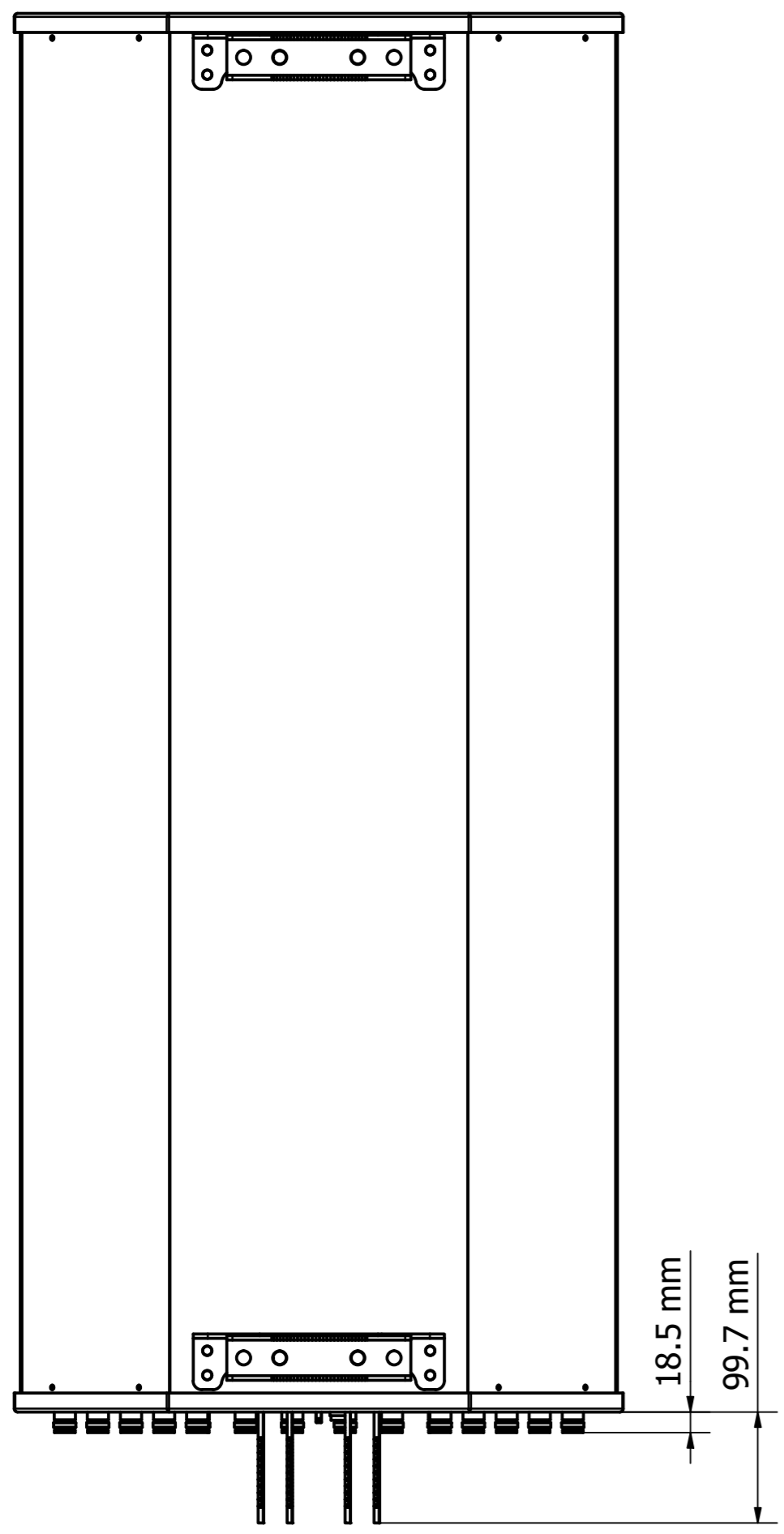
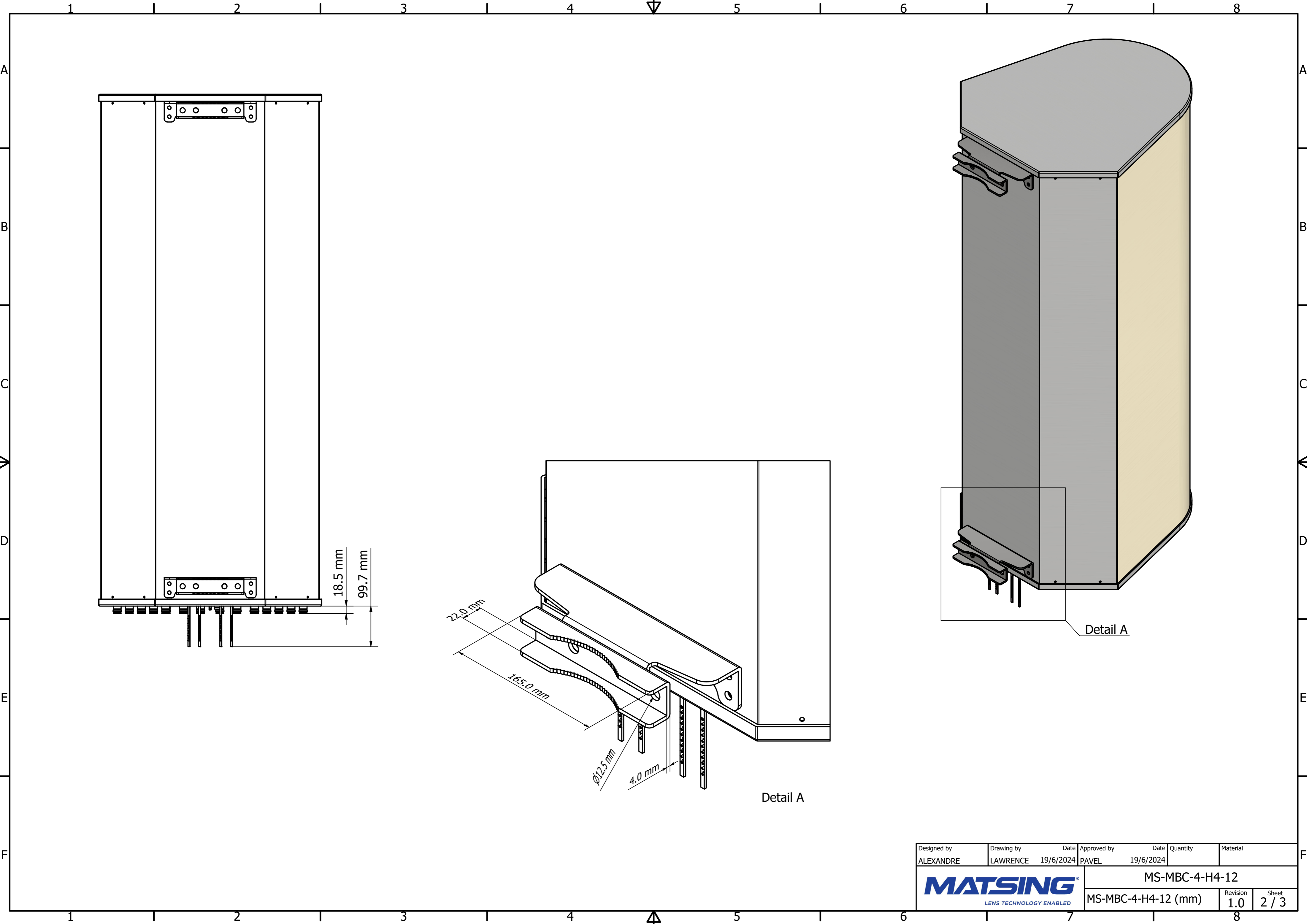

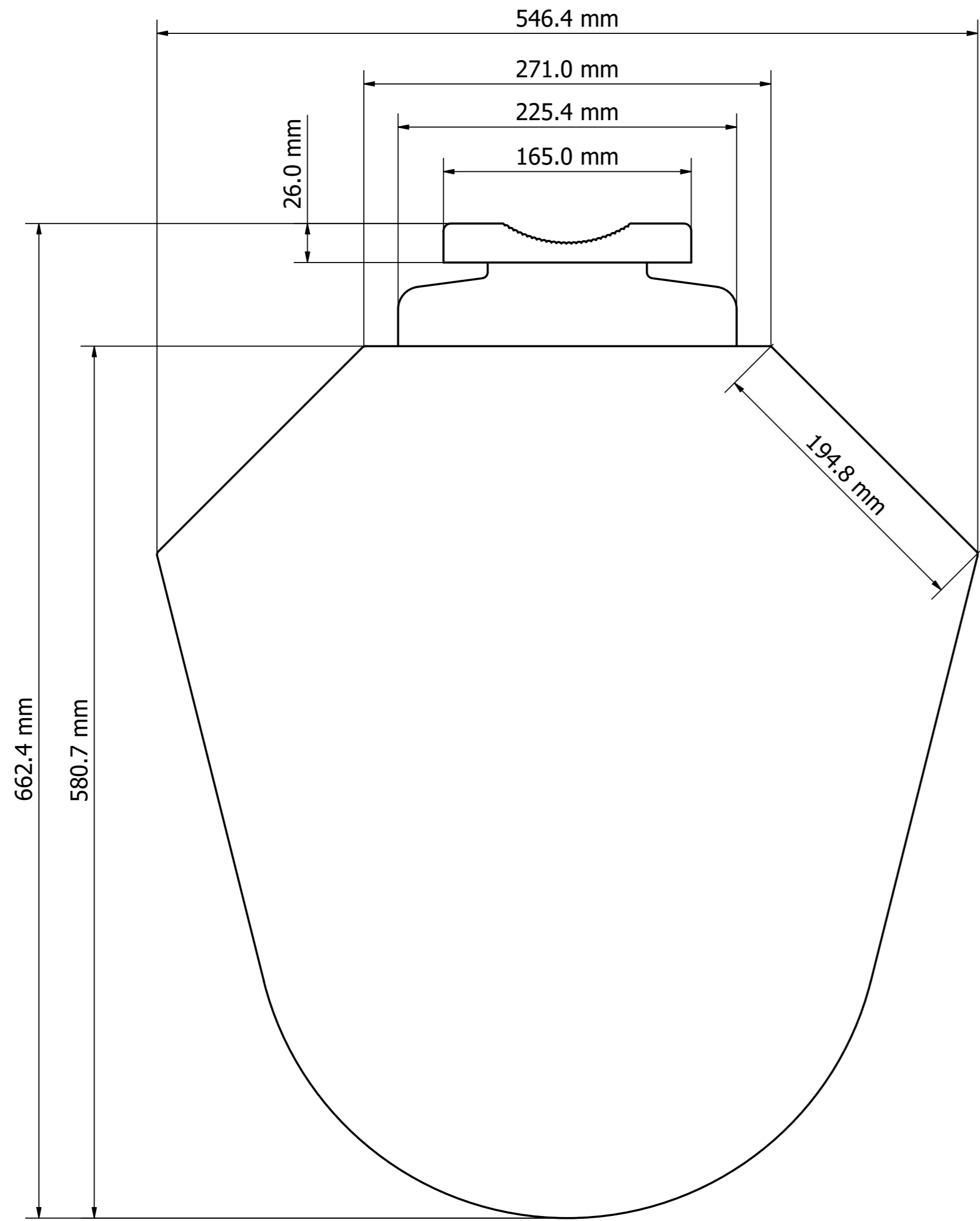
Top View

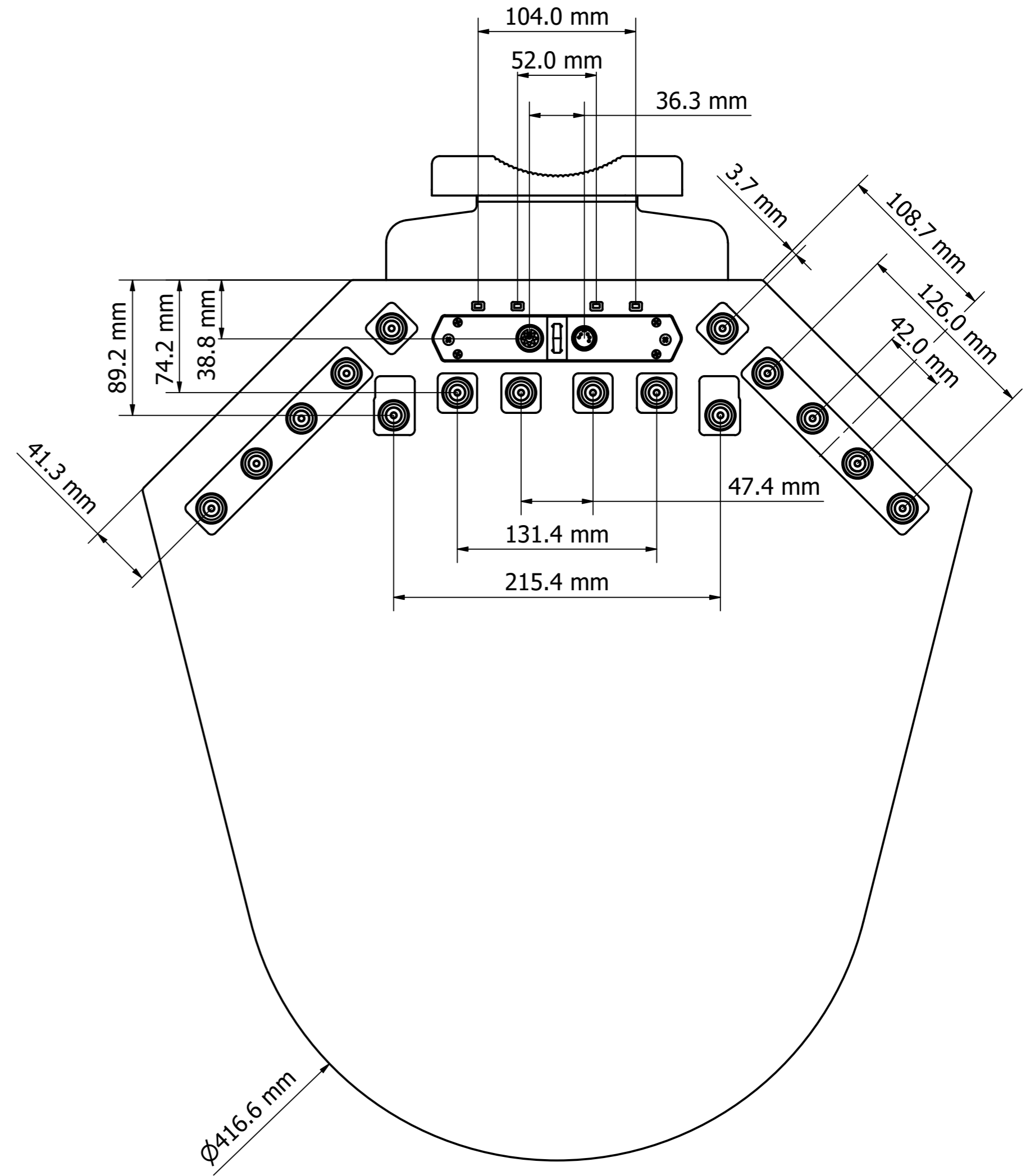

Bottom View

Designed by	Drawing by	Date	Approved by	Date	Quantity	Material
ALEXANDRE	LAWRENCE	19/6/2024	PAVEL	19/6/2024		
MATSING LENS TECHNOLOGY ENABLED						MS-MBC-4-H4-12
						MS-MBC-4-H4-12 (mm)
						Revision 1.0
						Sheet 3 / 3