

Designed by PAVEL	Drawing by LAWRENCE	Date 8/12/2021	Approved by PAVEL	Date 10/12/2021	Quantity	Material	
MATSING LENS TECHNOLOGY ENABLED						MS-MBA-4.4-SH2-SH2-45	
MS-MBA-4.4-SH2-SH2-45 (mm)						Revision 1.0	Sheet 1 / 3

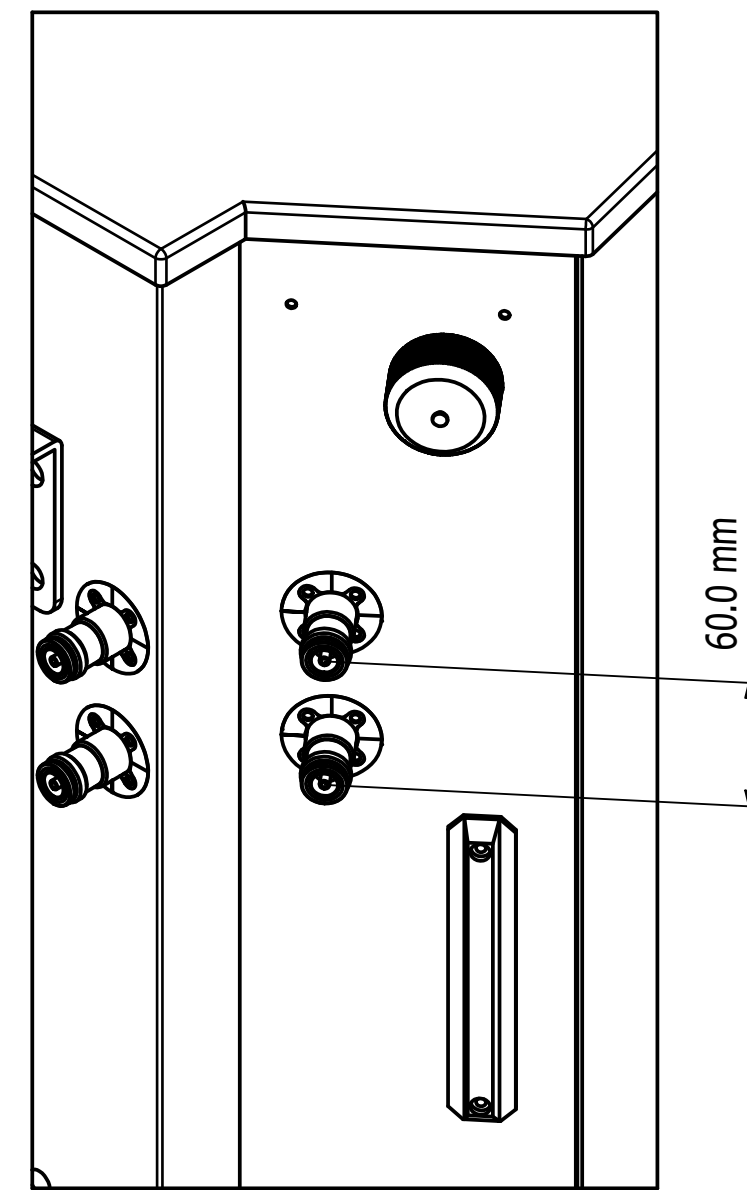

Detail C

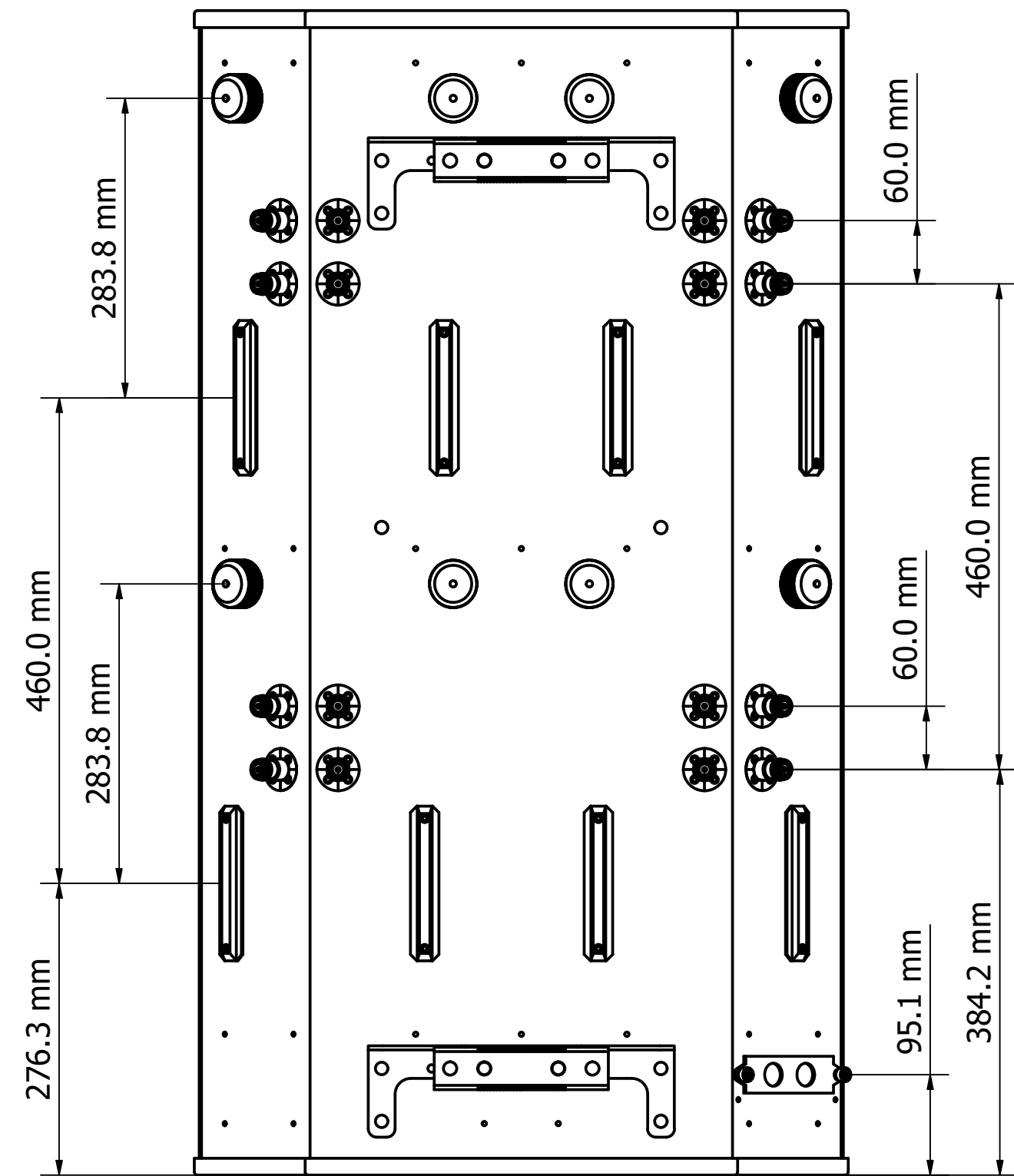
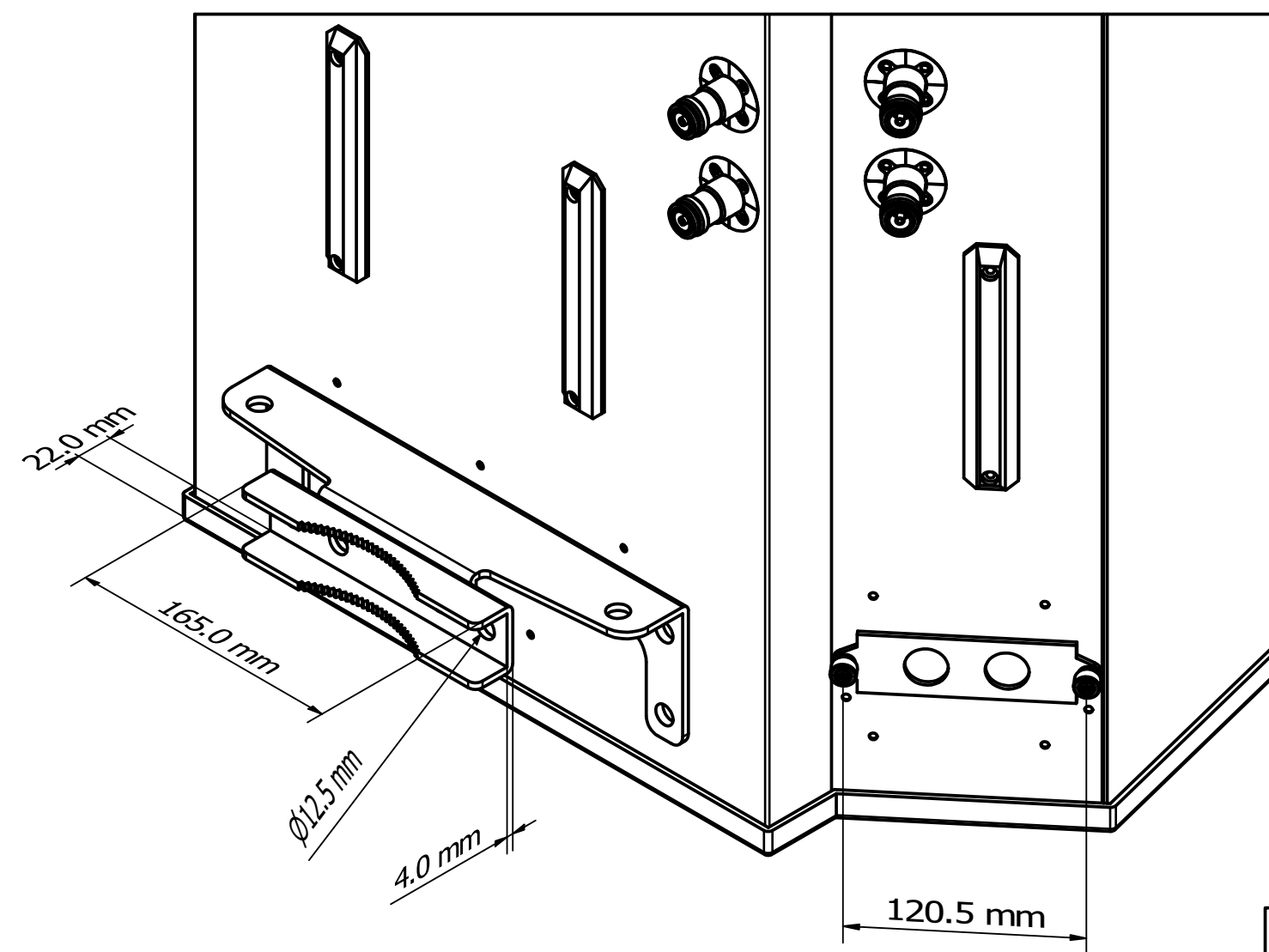

Detail B

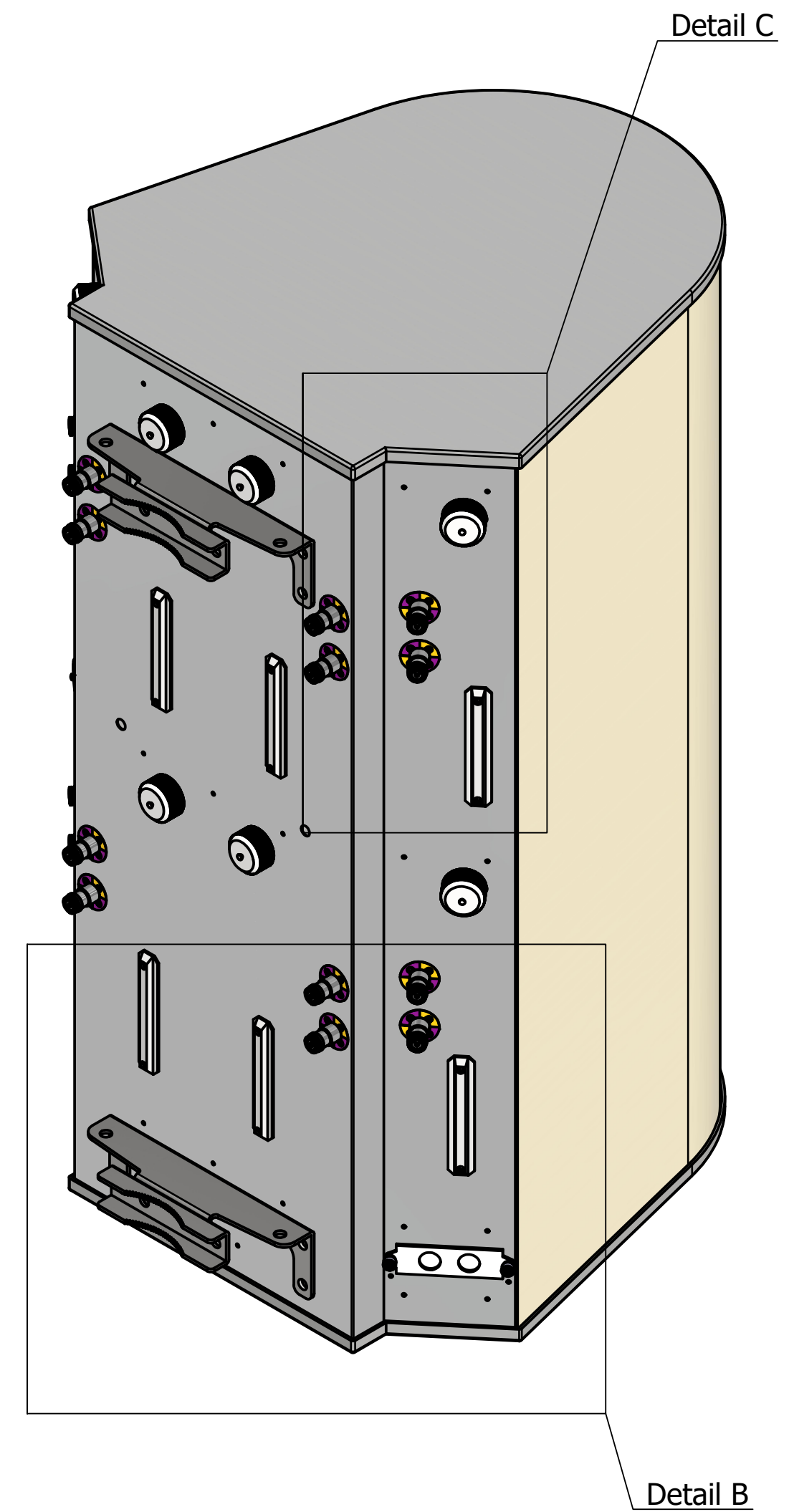

Designed by	Drawing by	Date	Approved by	Date	Quantity	Material
PAVEL	LAWRENCE	8/12/2021	PAVEL	10/12/2021		
MATSING						MS-MBA-4.4-SH2-SH2-45
<small>LENS TECHNOLOGY ENABLED</small>						MS-MBA-4.4-SH2-SH2-45 (mm)
					Revision	Sheet
					1.0	2 / 3

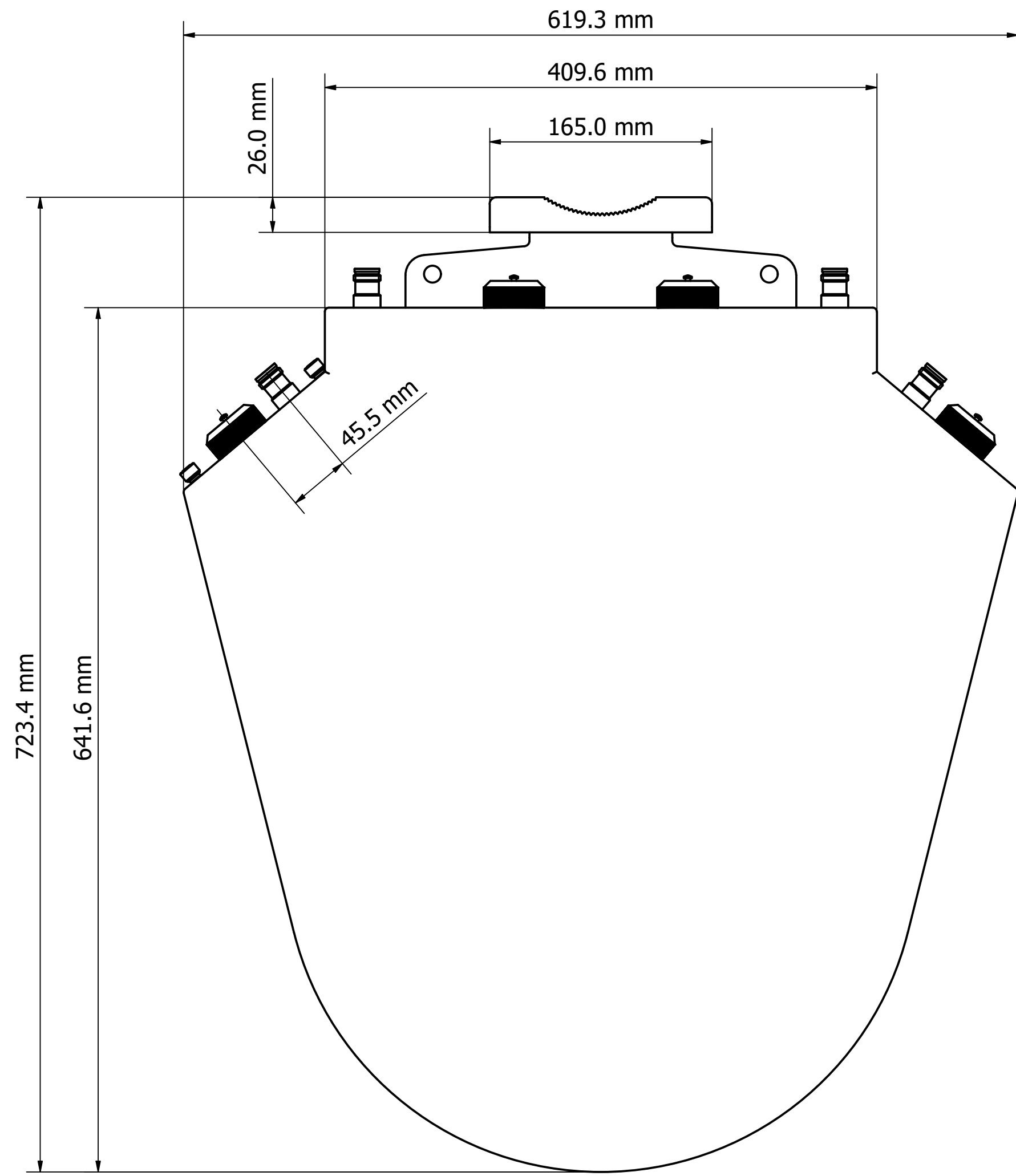

Top View

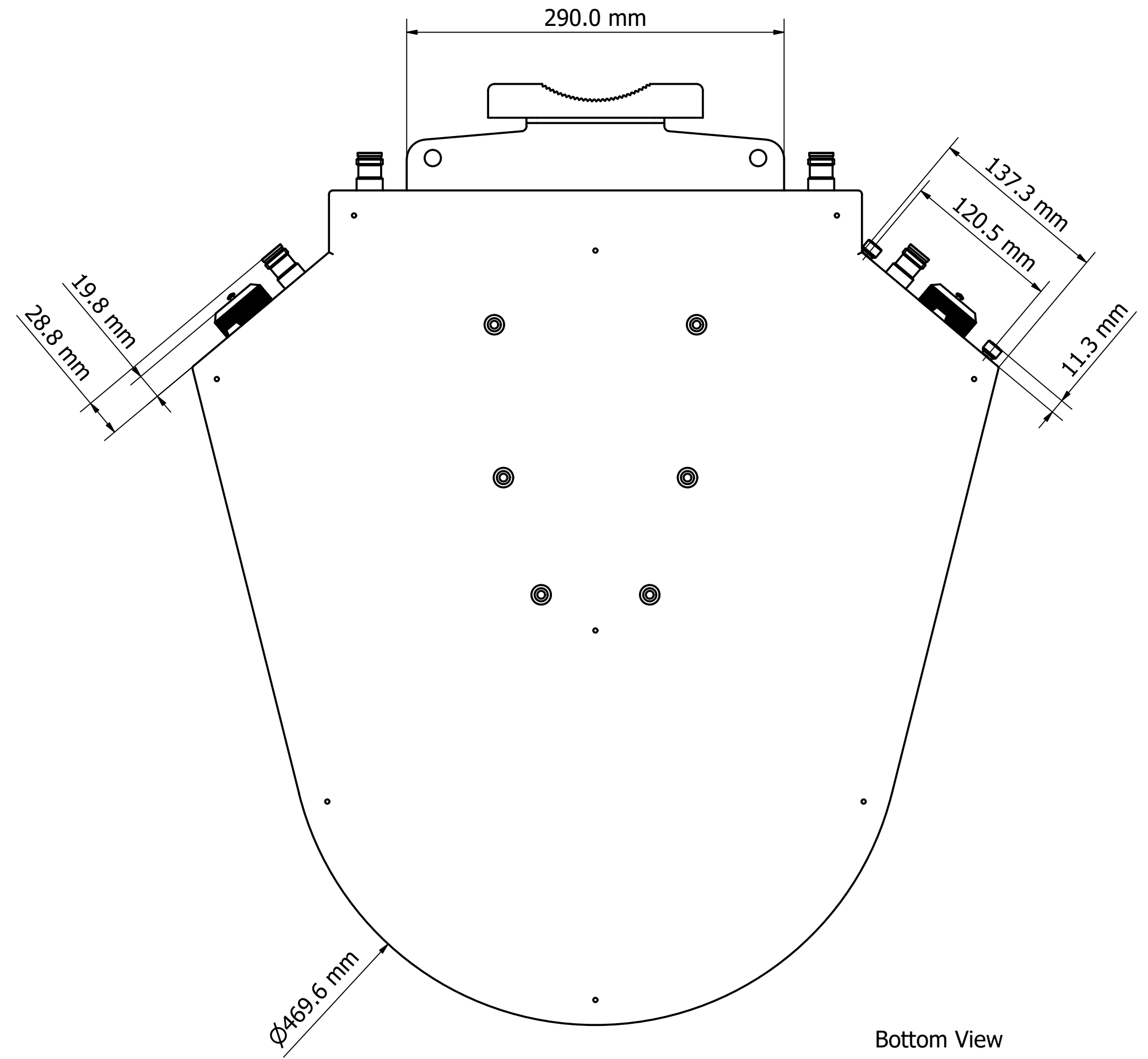

Bottom View

Designed by PAVEL	Drawing by LAWRENCE	Date 8/12/2021	Approved by PAVEL	Date 10/12/2021	Quantity	Material
 MATSING <small>LENS TECHNOLOGY ENABLED</small>						MS-MBA-4.4-SH2-SH2-45
						MS-MBA-4.4-SH2-SH2-45 (mm)