

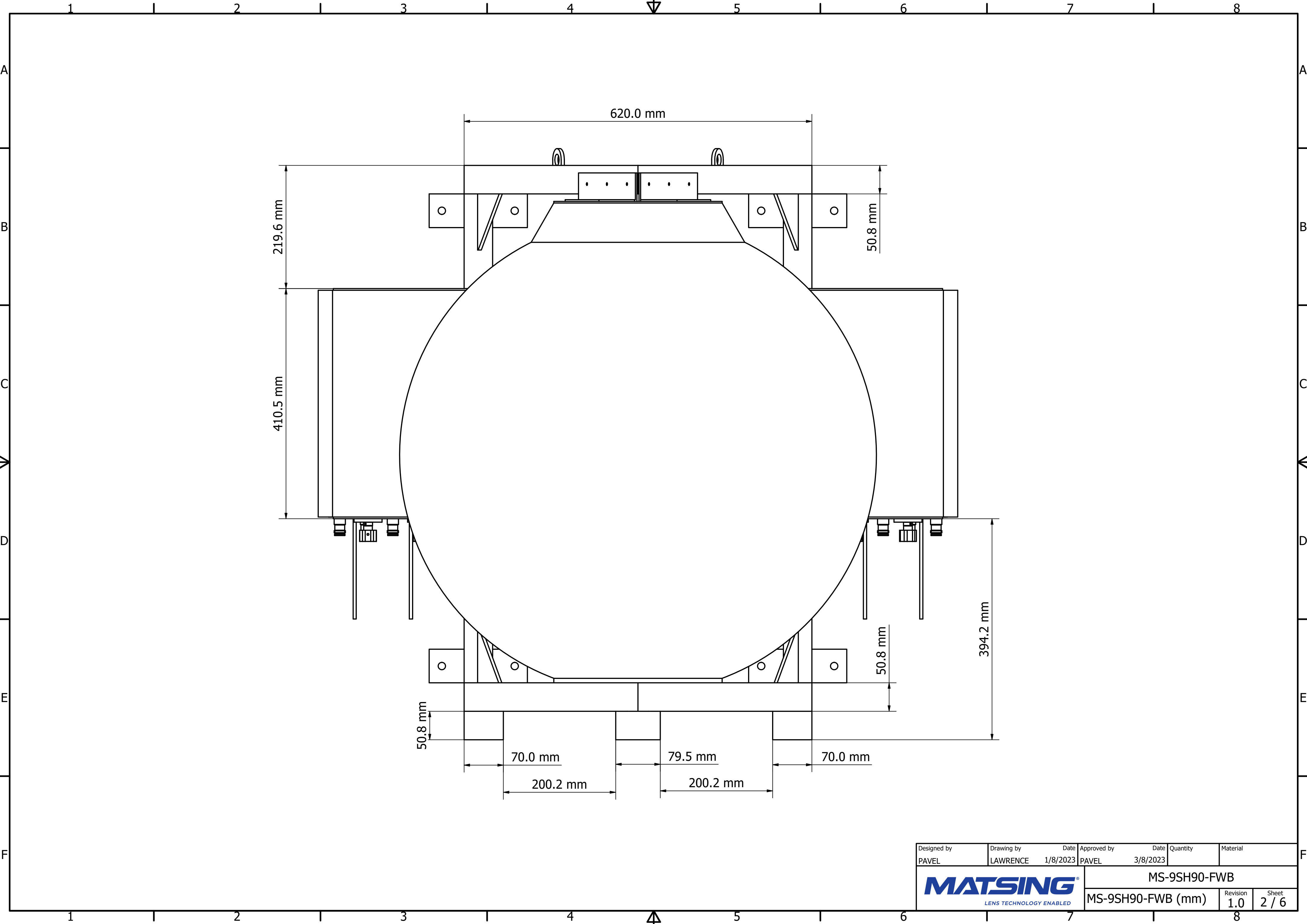



Designed by PAVEL	Drawing by LAWRENCE	Date 1/8/2023	Approved by PAVEL	Date 3/8/2023	Quantity	Material	
MATSING LENS TECHNOLOGY ENABLED						MS-9SH90-FWB	
MS-9SH90-FWB (mm)						Revision 1.0	Sheet 1 / 6



Designed by PAVEL	Drawing by LAWRENCE	Date 1/8/2023	Approved by PAVEL	Date 3/8/2023	Quantity	Material
 <small>LENS TECHNOLOGY ENABLED</small>			MS-9SH90-FWB			
			MS-9SH90-FWB (mm)			Revision 1.0

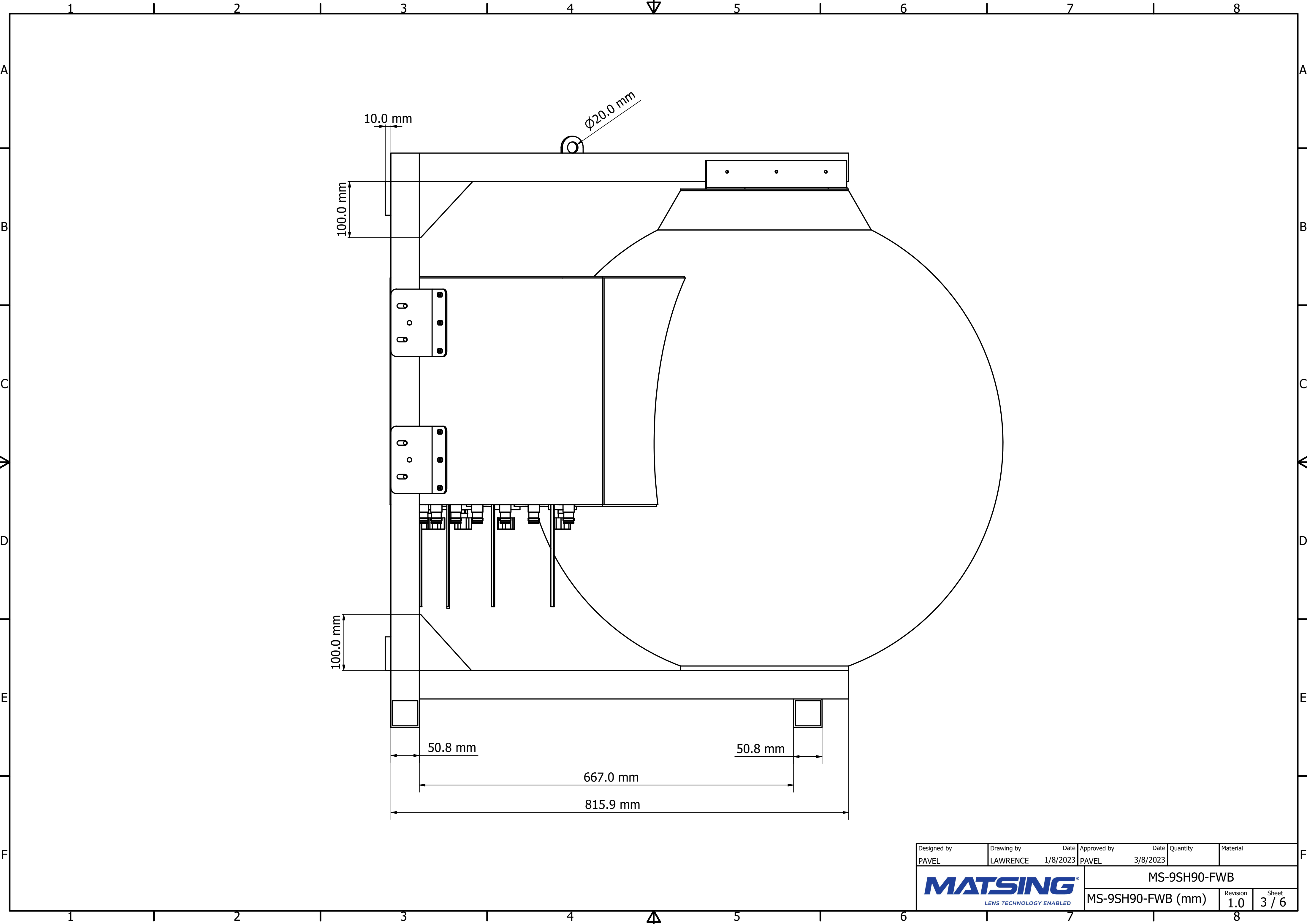

Designed by PAVEL	Drawing by LAWRENCE	Date 1/8/2023	Approved by PAVEL	Date 3/8/2023	Quantity	Material
 MATSING <small>LENS TECHNOLOGY ENABLED</small>						MS-9SH90-FWB
						MS-9SH90-FWB (mm)

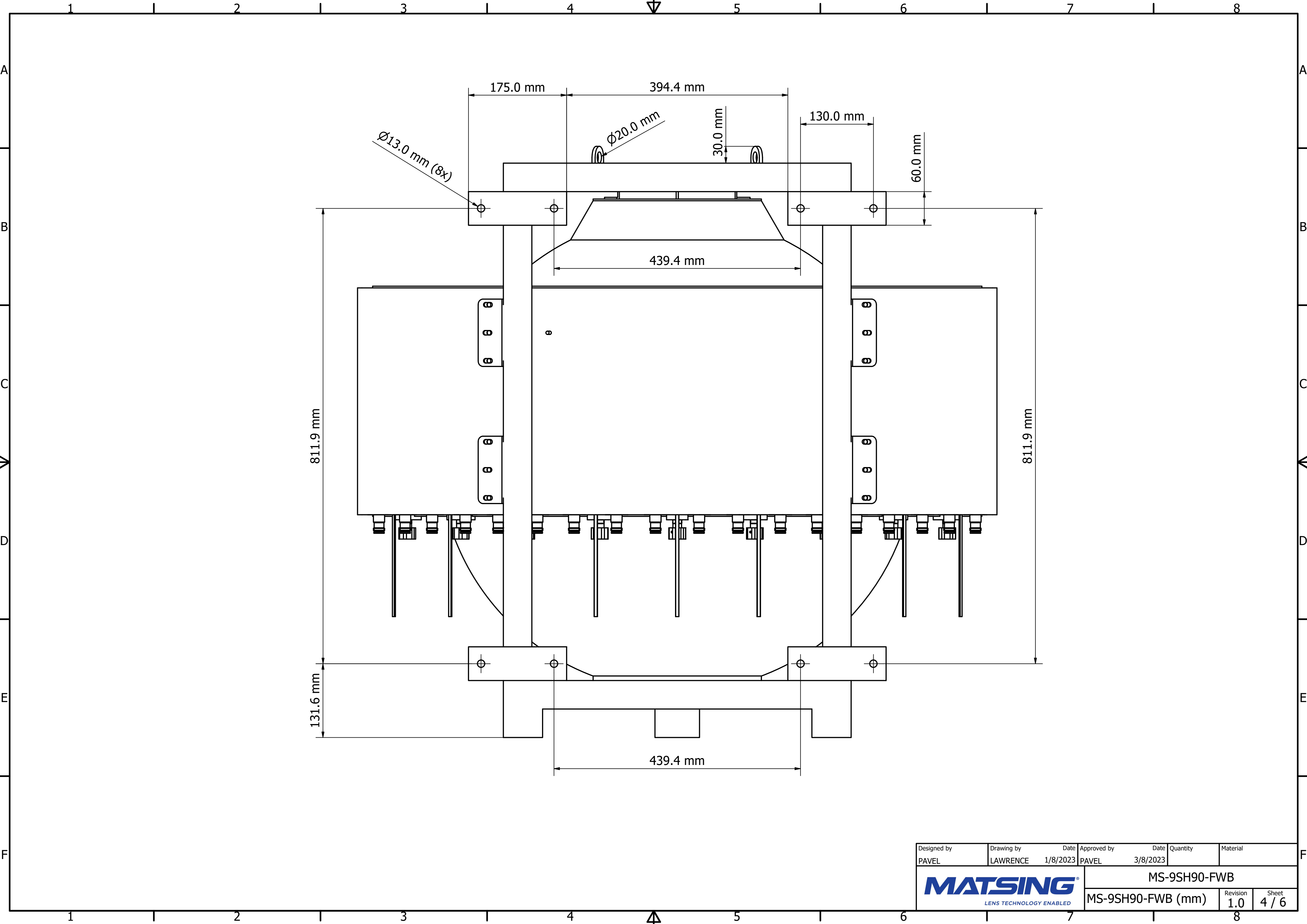

Designed by PAVEL	Drawing by LAWRENCE	Date 1/8/2023	Approved by PAVEL	Date 3/8/2023	Quantity	Material
 MATSING <small>LENS TECHNOLOGY ENABLED</small>						MS-9SH90-FWB
						MS-9SH90-FWB (mm)

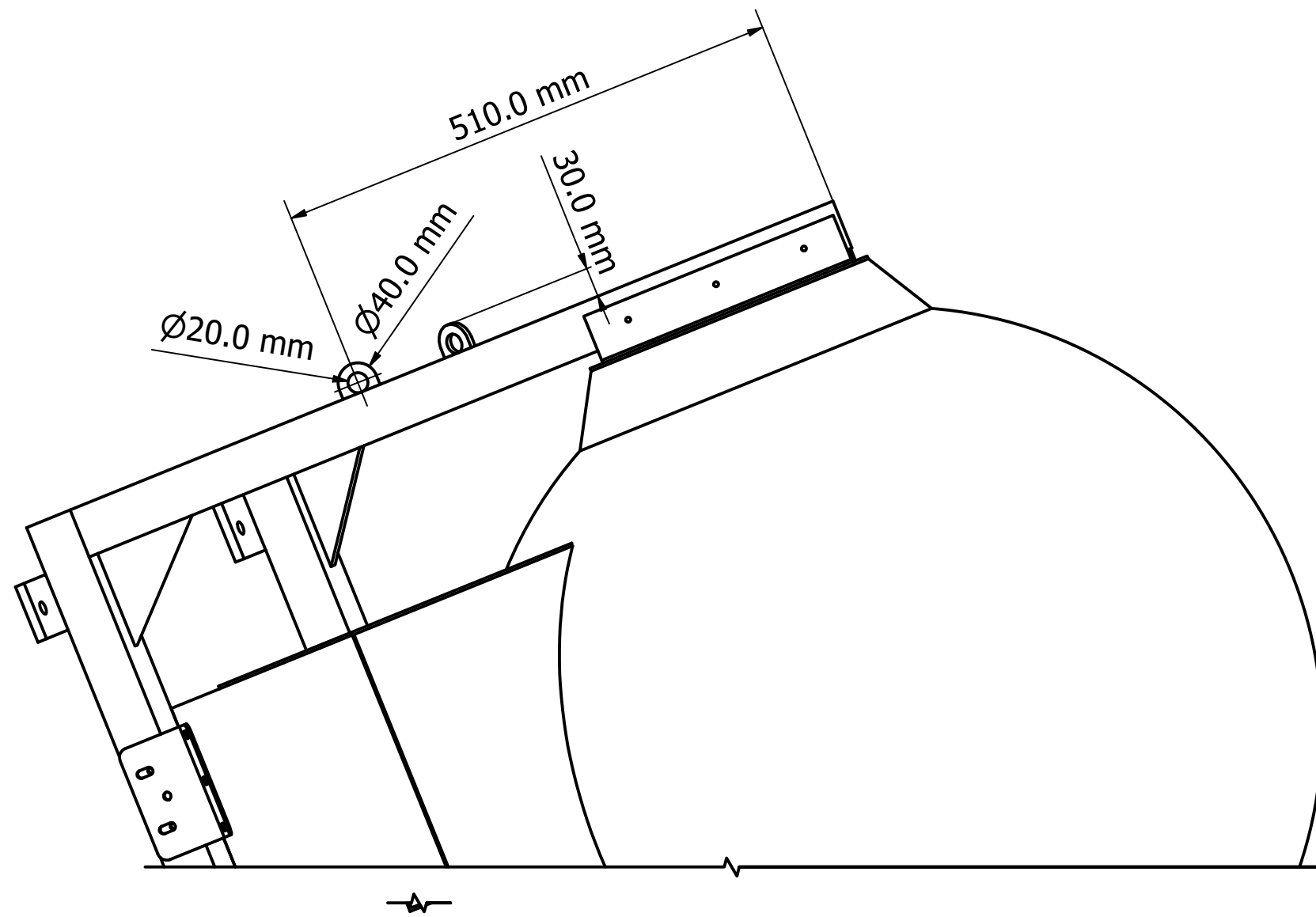

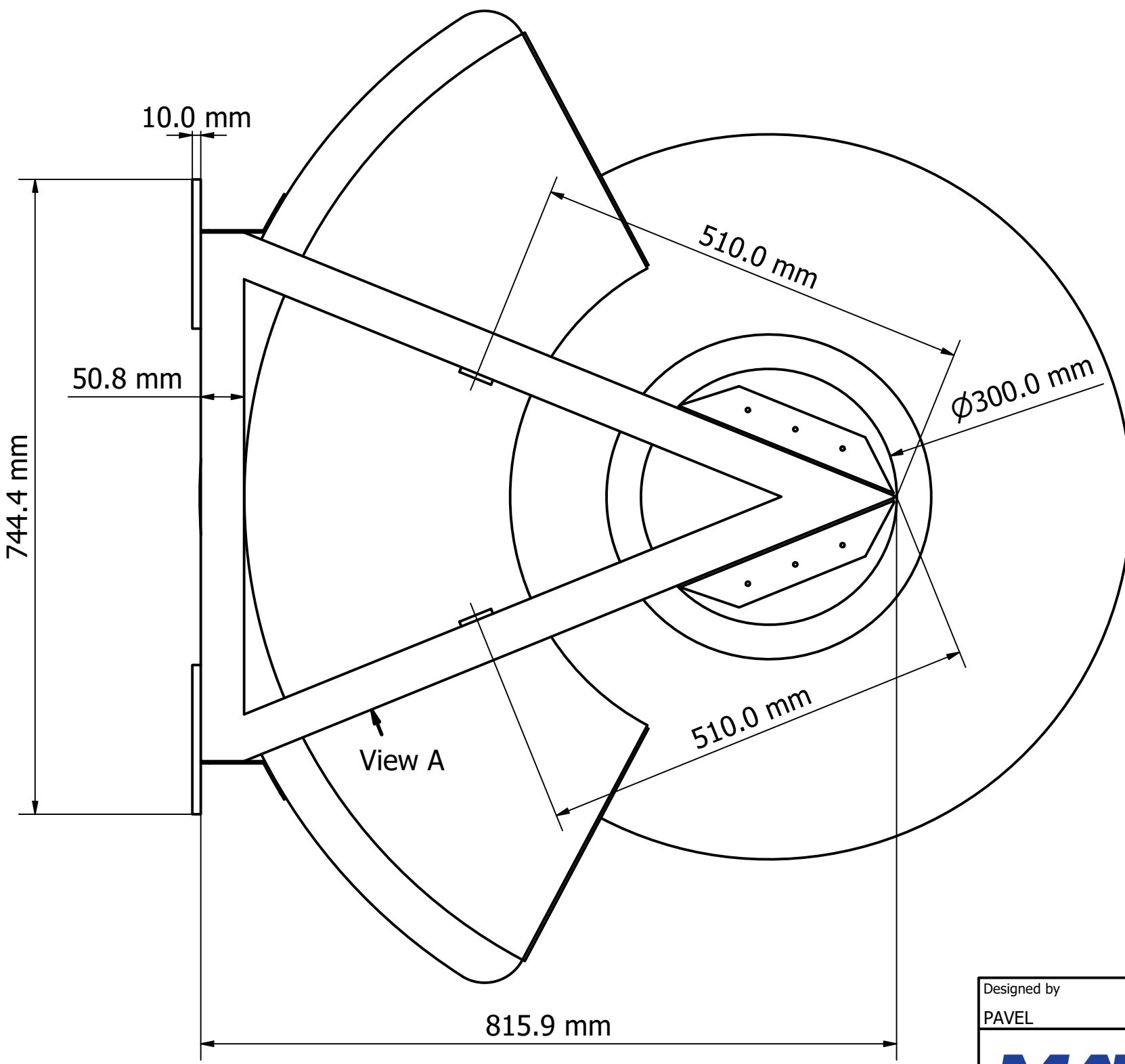

View A

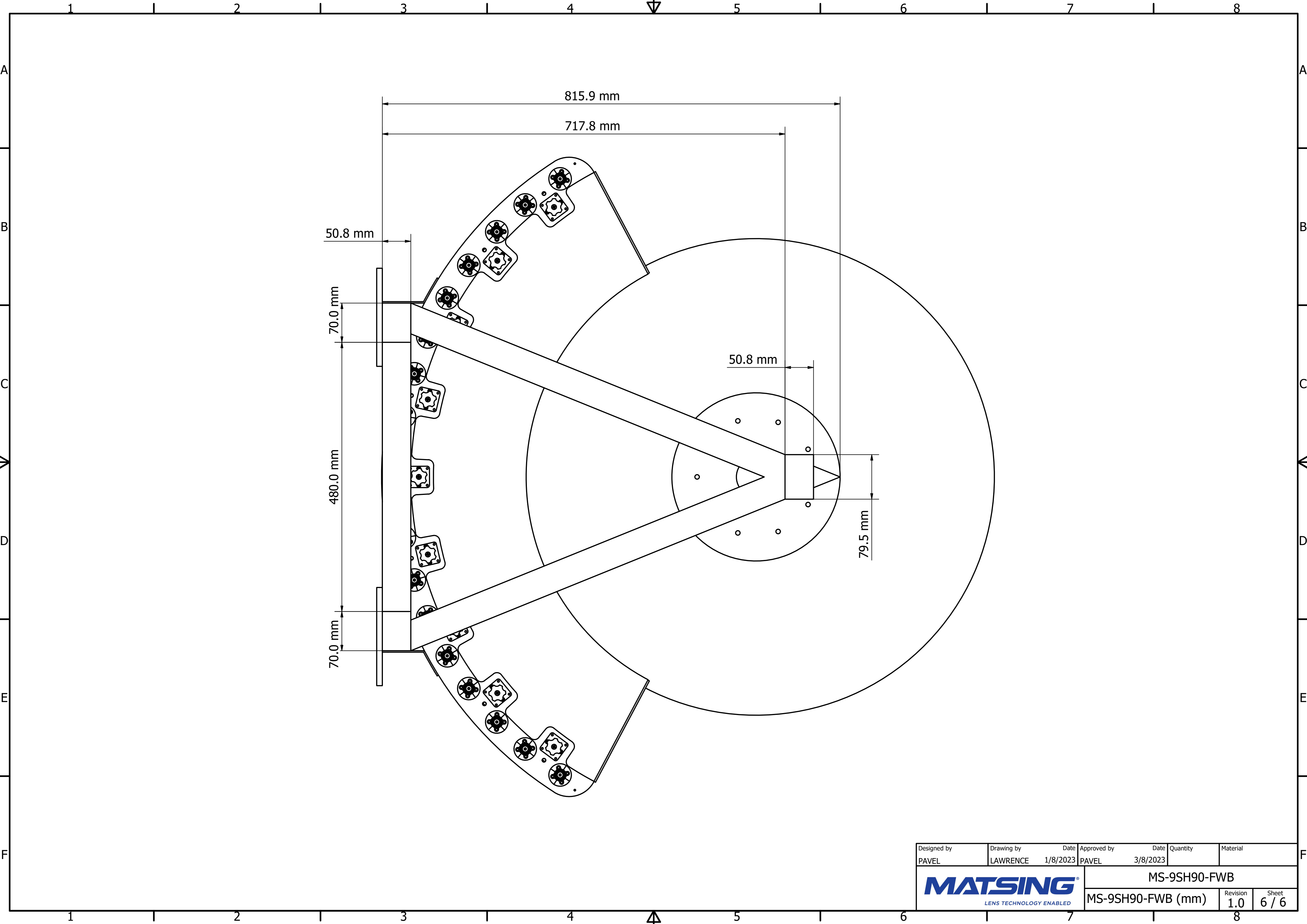

View A

Designed by PAVEL	Drawing by LAWRENCE	Date 1/8/2023	Approved by PAVEL	Date 3/8/2023	Quantity	Material
MATSING LENS TECHNOLOGY ENABLED						MS-9SH90-FWB
MS-9SH90-FWB (mm)					Revision 1.0	Sheet 5 / 6



Designed by PAVEL	Drawing by LAWRENCE	Date 1/8/2023	Approved by PAVEL	Date 3/8/2023	Quantity	Material
						MS-9SH90-FWB
						MS-9SH90-FWB (mm)