

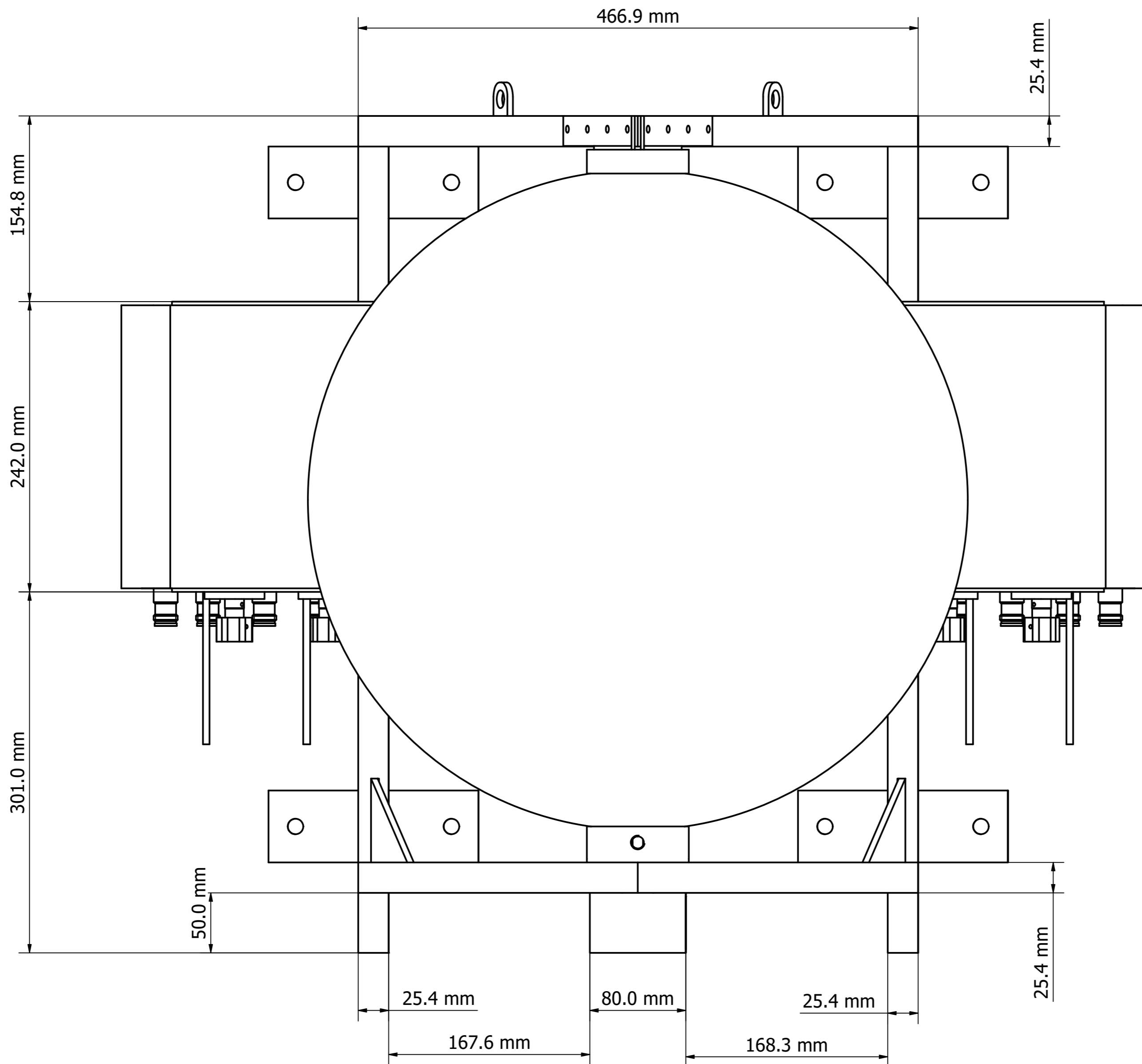

Designed by VIGNESH	Drawing by LAWRENCE	Date 7/3/2024	Approved by PAVEL	Date 7/3/2024	Quantity	Material
<b>MATSING</b> LENS TECHNOLOGY ENABLED						MS-8C60
MS-8C60 (mm)					Revision 1.0	Sheet 1 / 6



Designed by VIGNESH	Drawing by LAWRENCE	Date 7/3/2024	Approved by PAVEL	Date 7/3/2024	Quantity	Material
						MS-8C60
						MS-8C60 (mm)

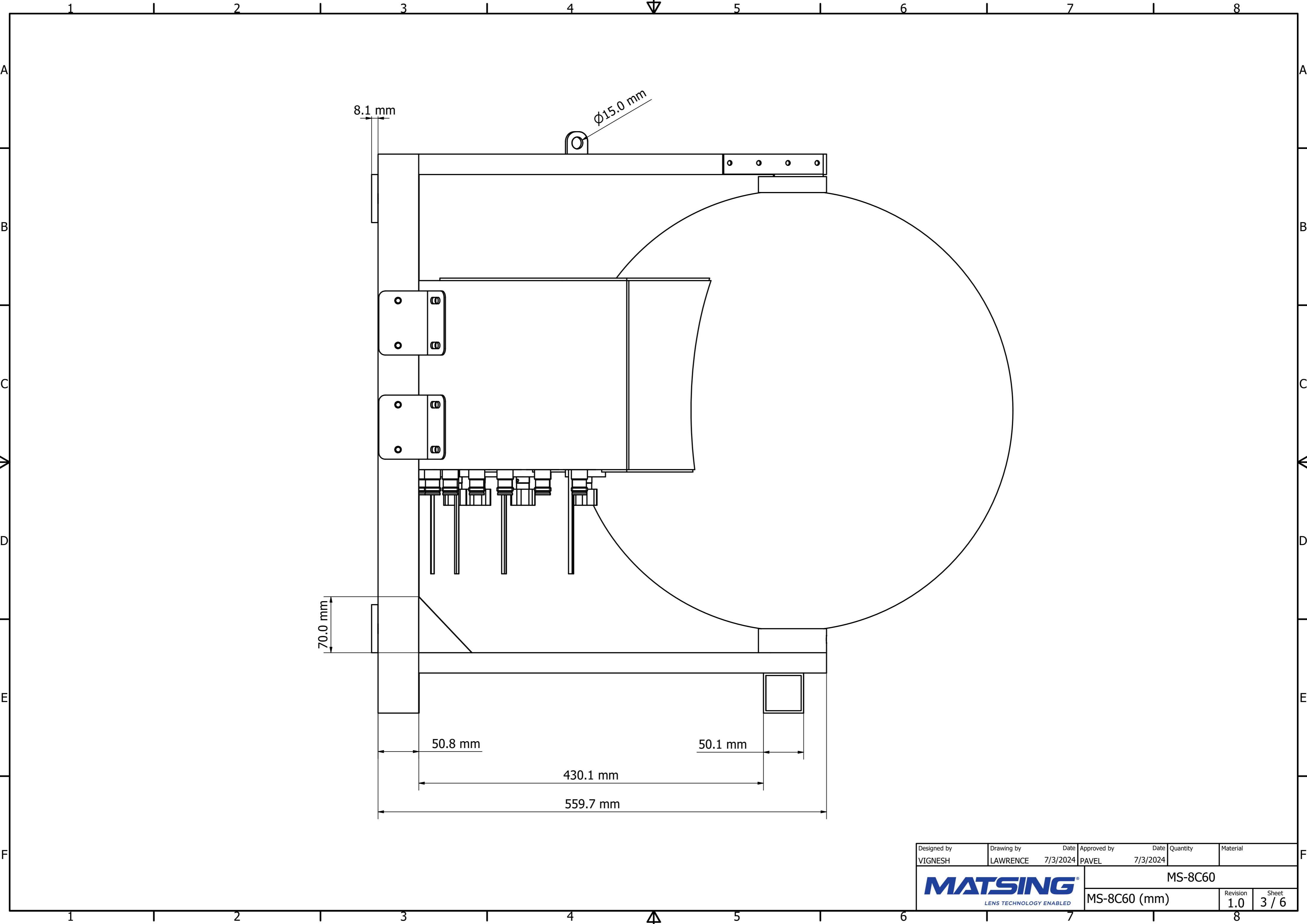

Designed by VIGNESH	Drawing by LAWRENCE	Date 7/3/2024	Approved by PAVEL	Date 7/3/2024	Quantity	Material
<b>MATSING</b> LENS TECHNOLOGY ENABLED						MS-8C60
MS-8C60 (mm)					Revision 1.0	Sheet 3 / 6

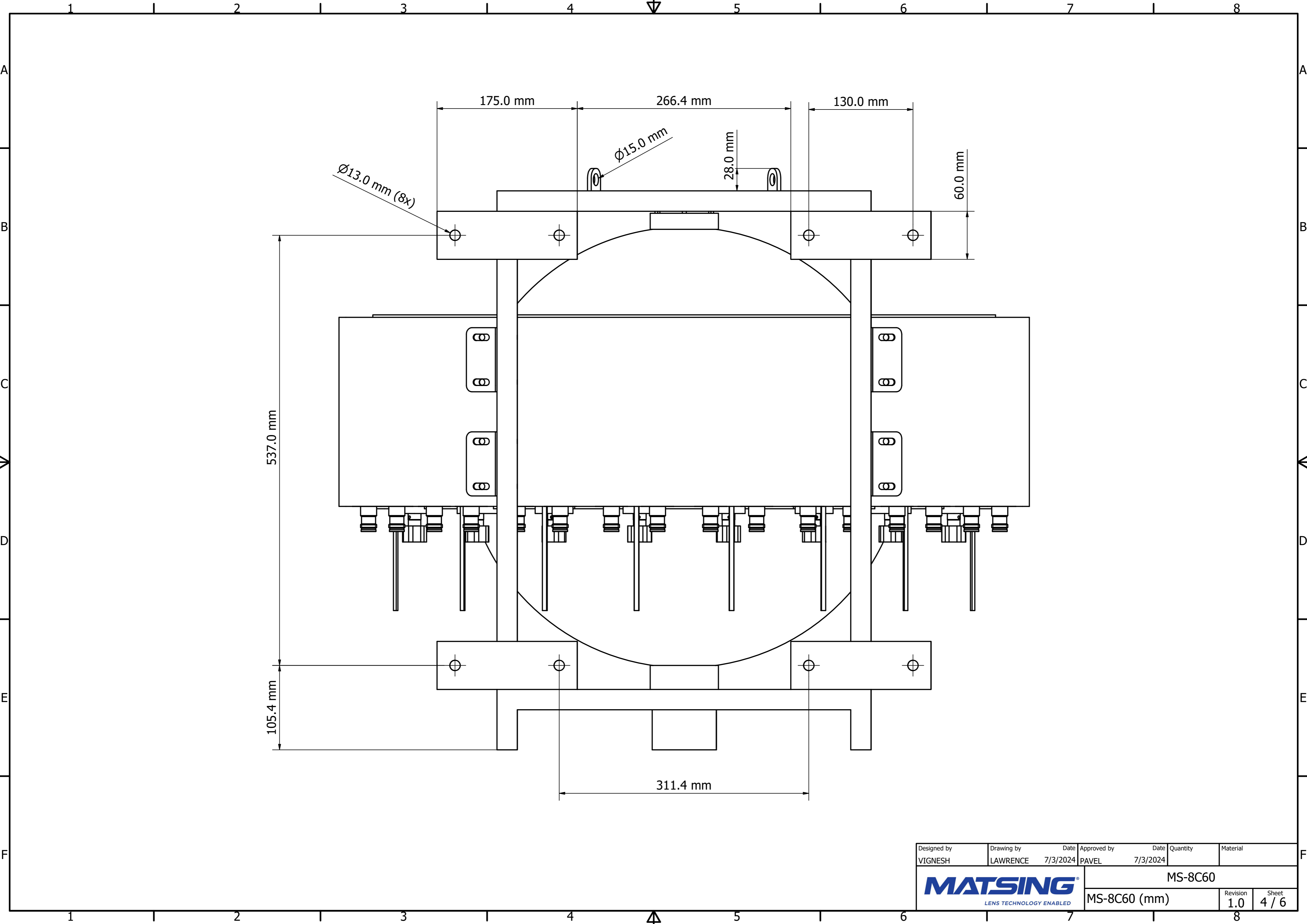

Designed by VIGNESH	Drawing by LAWRENCE	Date 7/3/2024	Approved by PAVEL	Date 7/3/2024	Quantity	Material
<b>MATSING</b> LENS TECHNOLOGY ENABLED						MS-8C60
MS-8C60 (mm)					Revision 1.0	Sheet 4 / 6

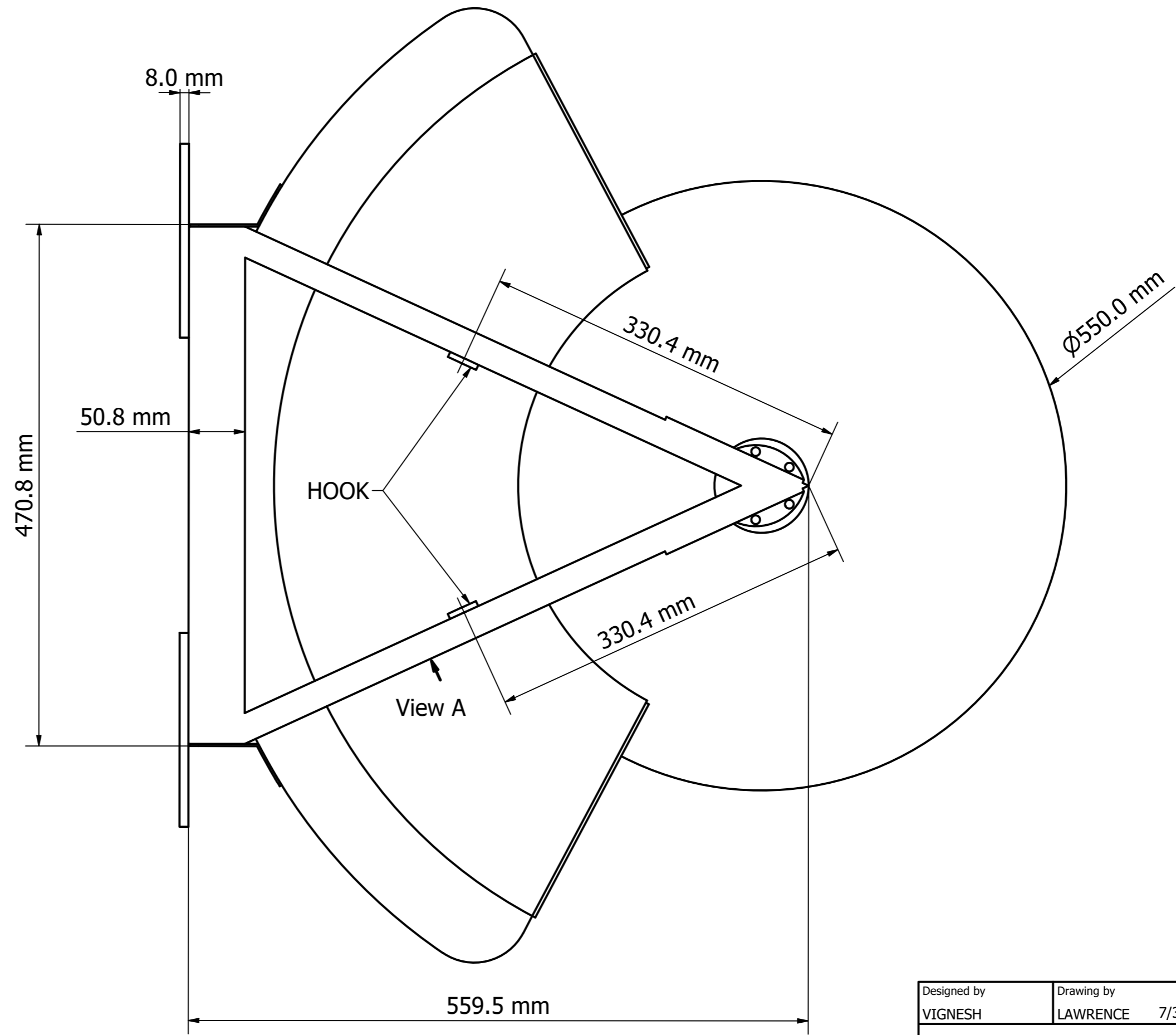
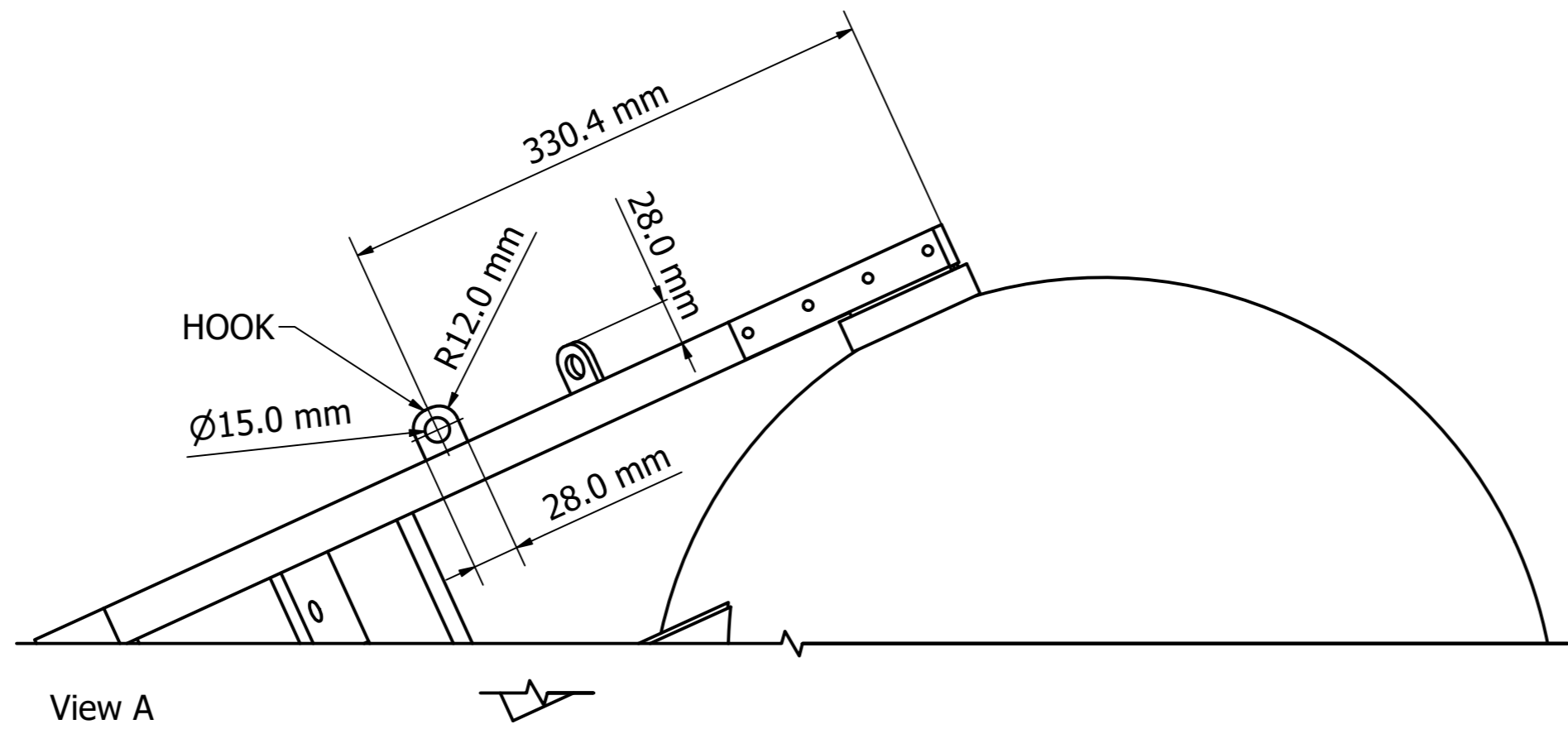

Designed by VIGNESH	Drawing by LAWRENCE	Date 7/3/2024	Approved by PAVEL	Date 7/3/2024	Quantity	Material
<b>MATSING</b> LENS TECHNOLOGY ENABLED						MS-8C60
MS-8C60 (mm)					Revision 1.0	Sheet 5 / 6

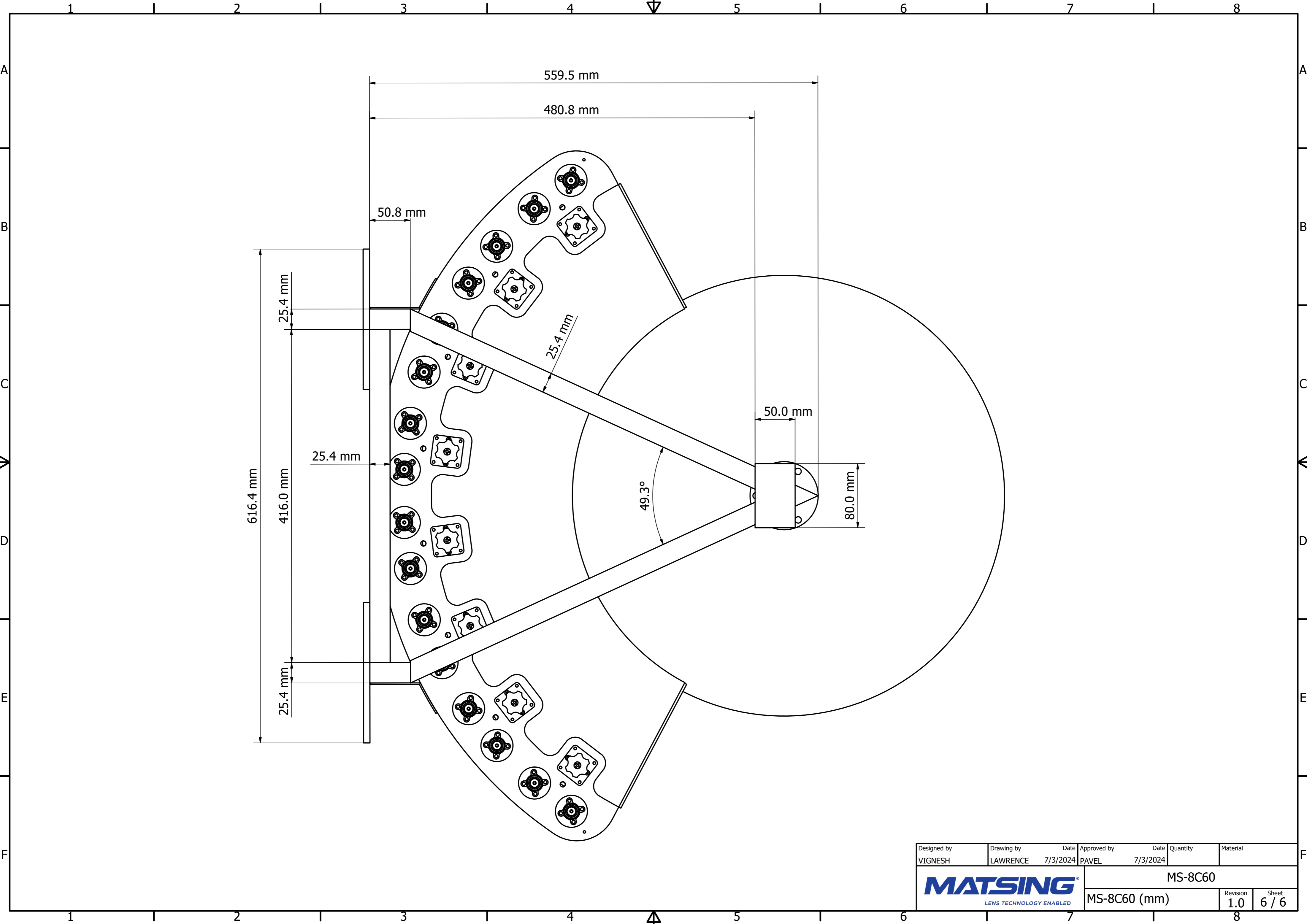

Designed by VIGNESH	Drawing by LAWRENCE	Date 7/3/2024	Approved by PAVEL	Date 7/3/2024	Quantity	Material
<b>MATSING</b> LENS TECHNOLOGY ENABLED						MS-8C60
MS-8C60 (mm)					Revision 1.0	Sheet 6 / 6