

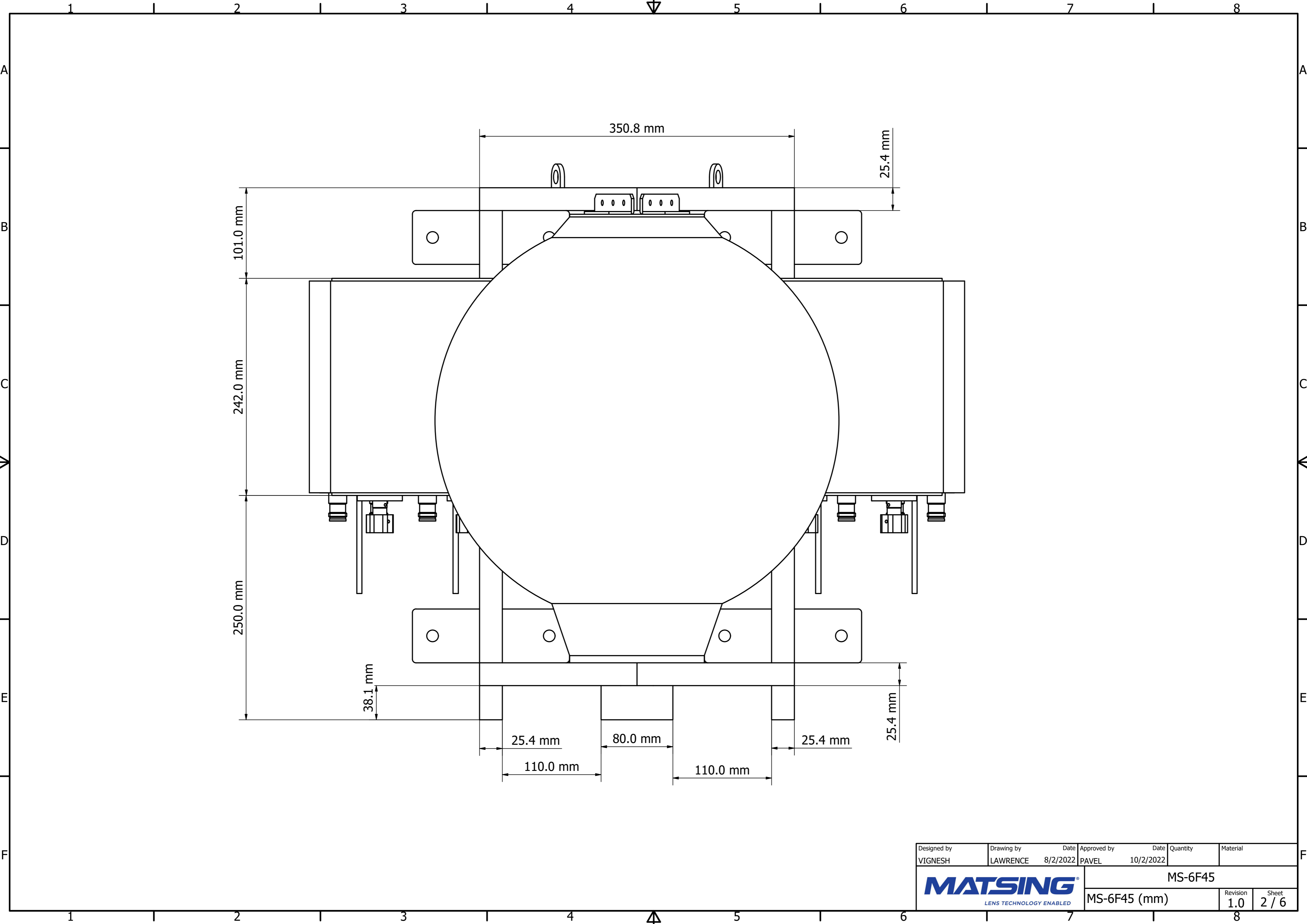



Designed by VIGNESH	Drawing by LAWRENCE	Date 8/2/2022	Approved by PAVEL	Date 10/2/2022	Quantity	Material
MATSING LENS TECHNOLOGY ENABLED						MS-6F45
					MS-6F45 (mm)	Revision 1.0
					Sheet 1 / 6	



Designed by VIGNESH	Drawing by LAWRENCE	Date 8/2/2022	Approved by PAVEL	Date 10/2/2022	Quantity	Material
 MATSING <small>LENS TECHNOLOGY ENABLED</small>						MS-6F45
						MS-6F45 (mm)

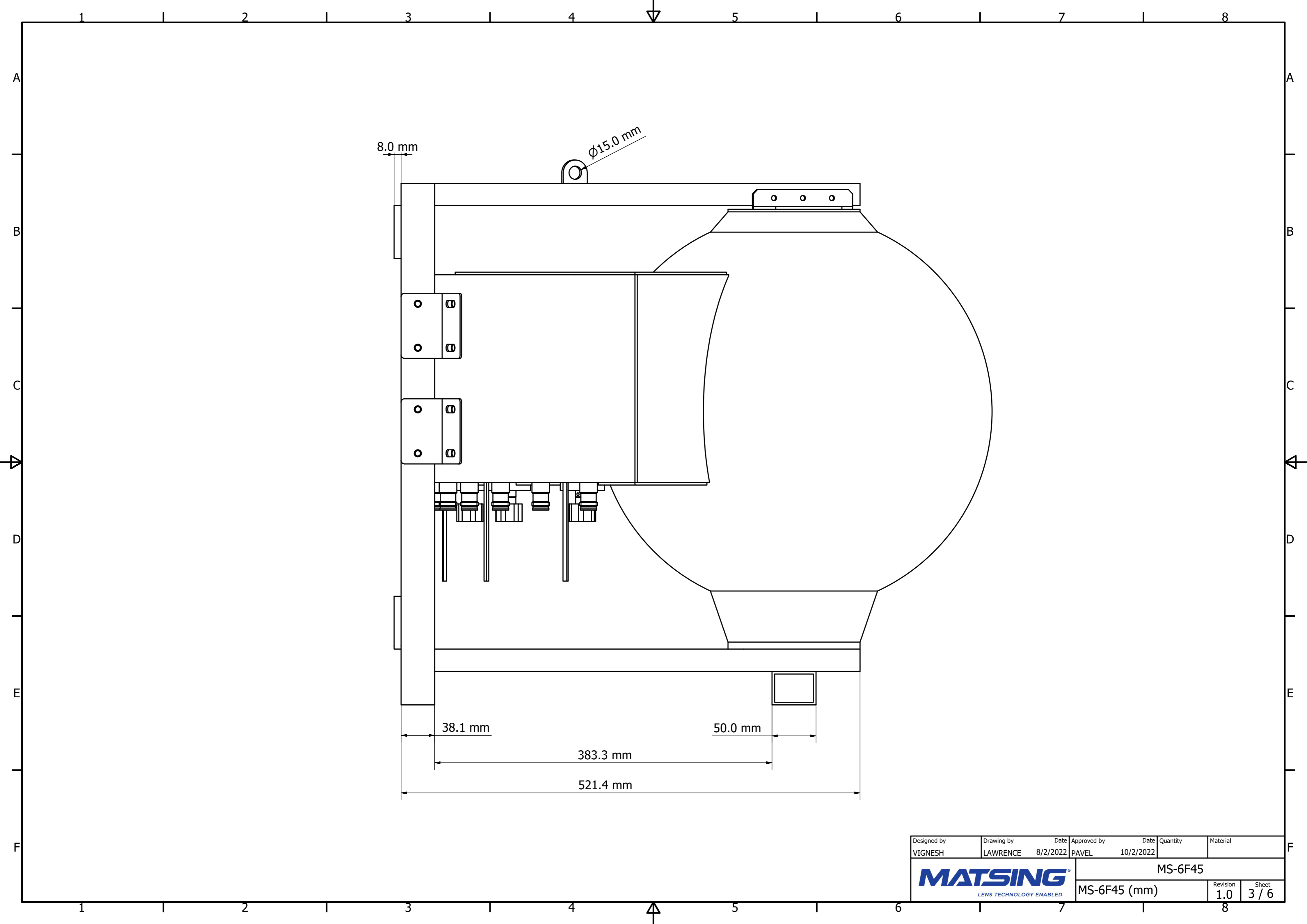

Designed by VIGNESH	Drawing by LAWRENCE	Date 8/2/2022	Approved by PAVEL	Date 10/2/2022	Quantity	Material
 MATSING <small>LENS TECHNOLOGY ENABLED</small>					MS-6F45	
					MS-6F45 (mm)	

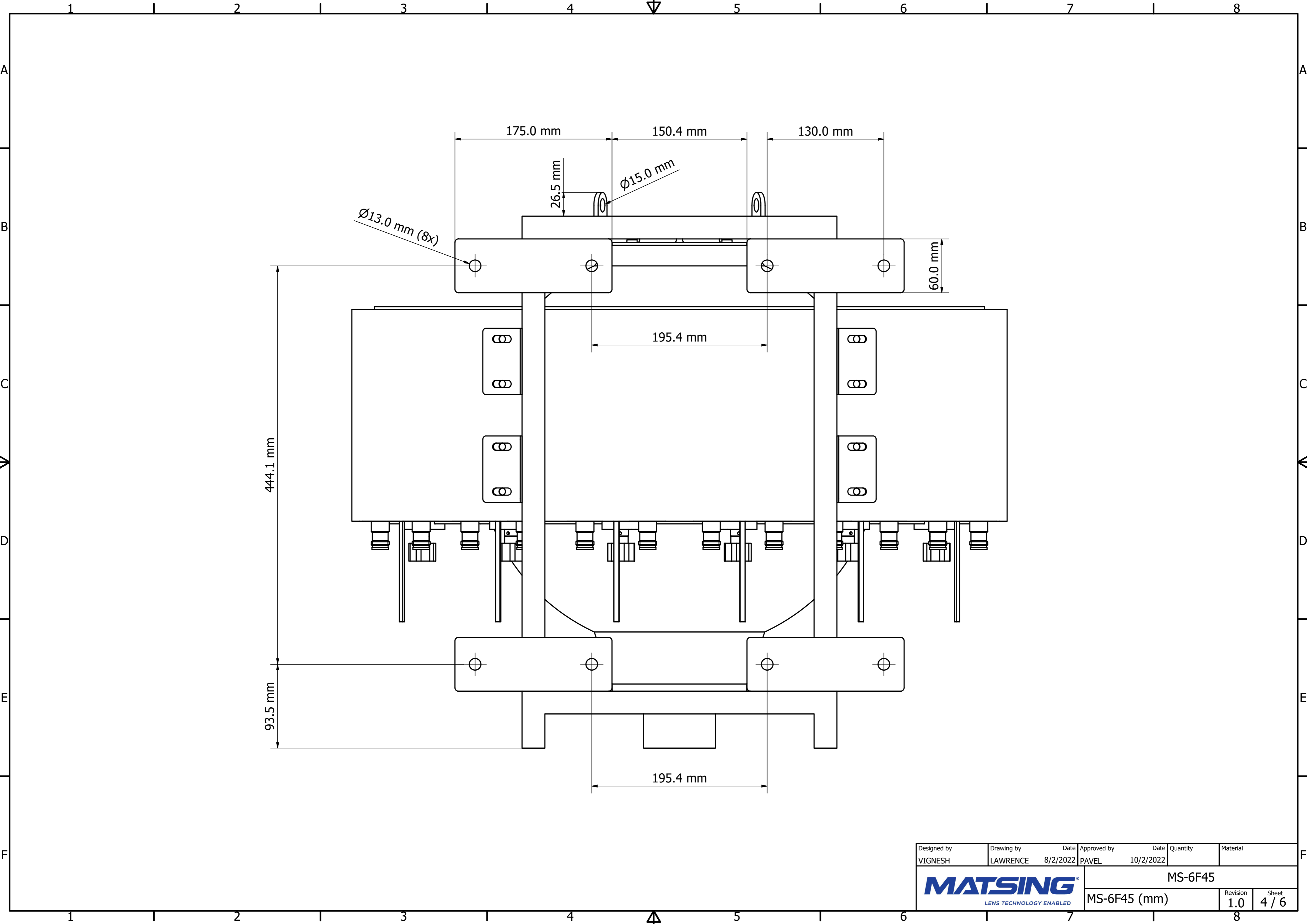

Designed by VIGNESH	Drawing by LAWRENCE	Date 8/2/2022	Approved by PAVEL	Date 10/2/2022	Quantity	Material
						MS-6F45
						MS-6F45 (mm)

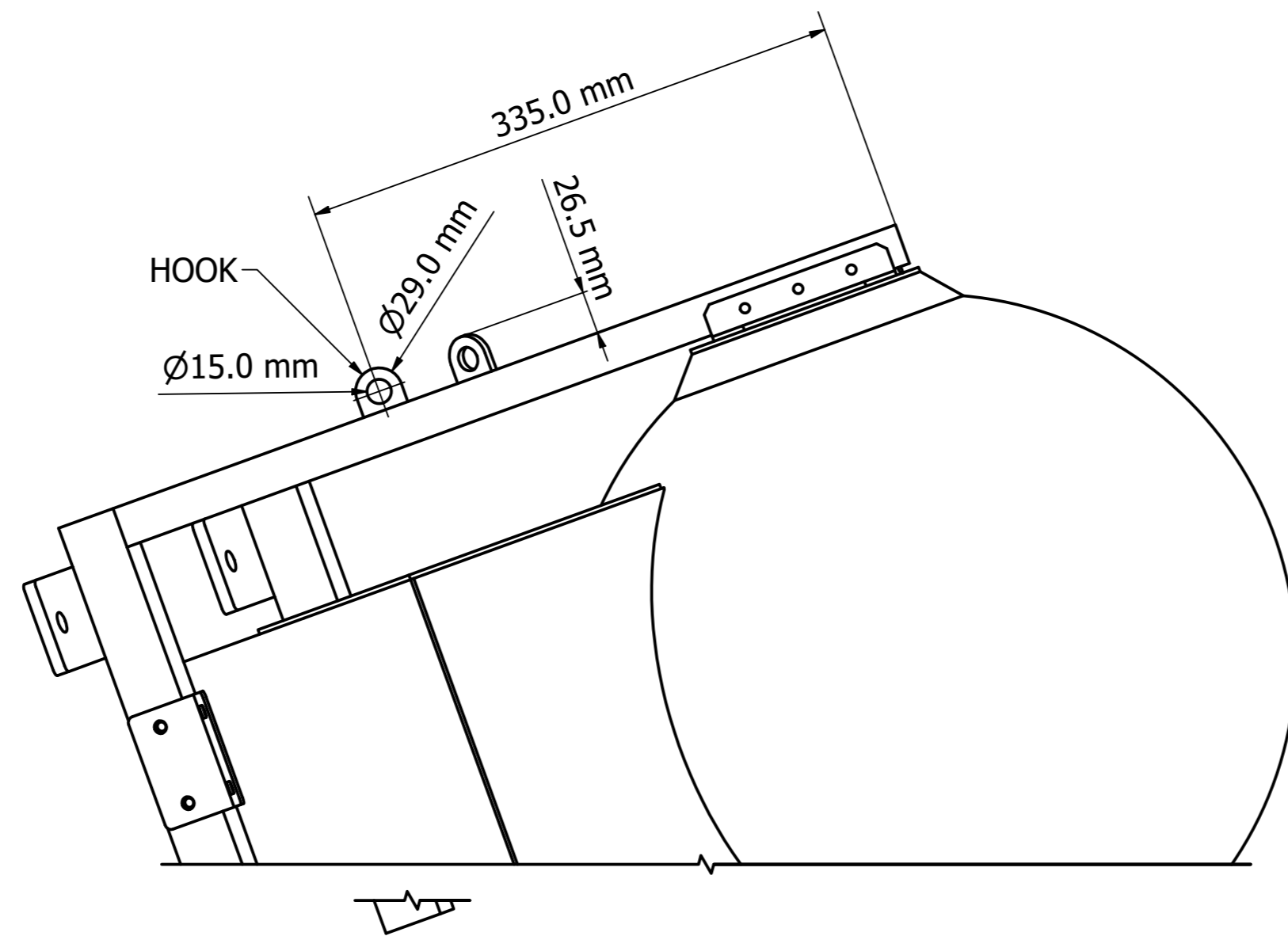

View A

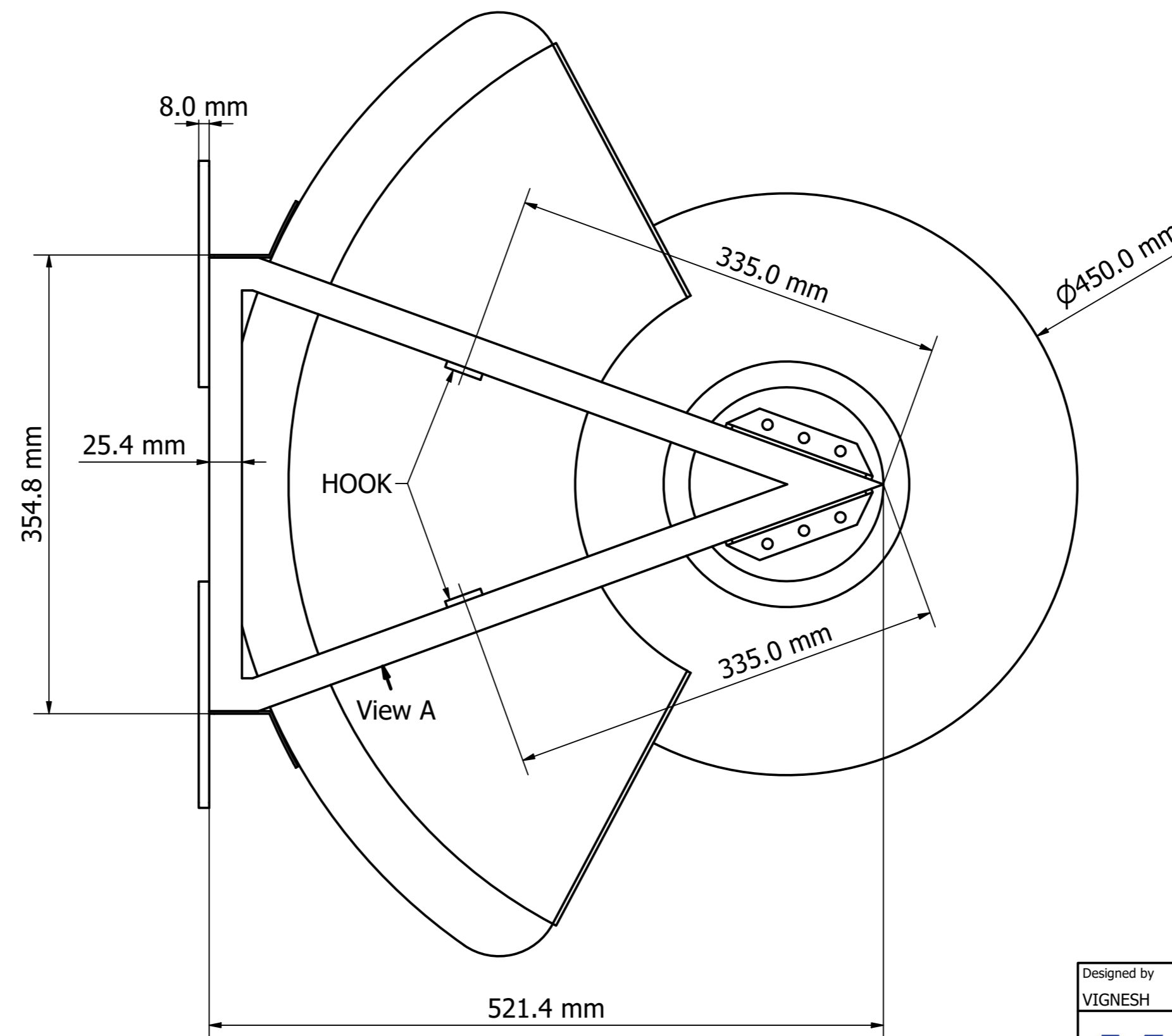

View A

Designed by VIGNESH	Drawing by LAWRENCE	Date 8/2/2022	Approved by PAVEL	Date 10/2/2022	Quantity	Material
MATSING LENS TECHNOLOGY ENABLED						MS-6F45
MS-6F45 (mm)					Revision 1.0	Sheet 5 / 6

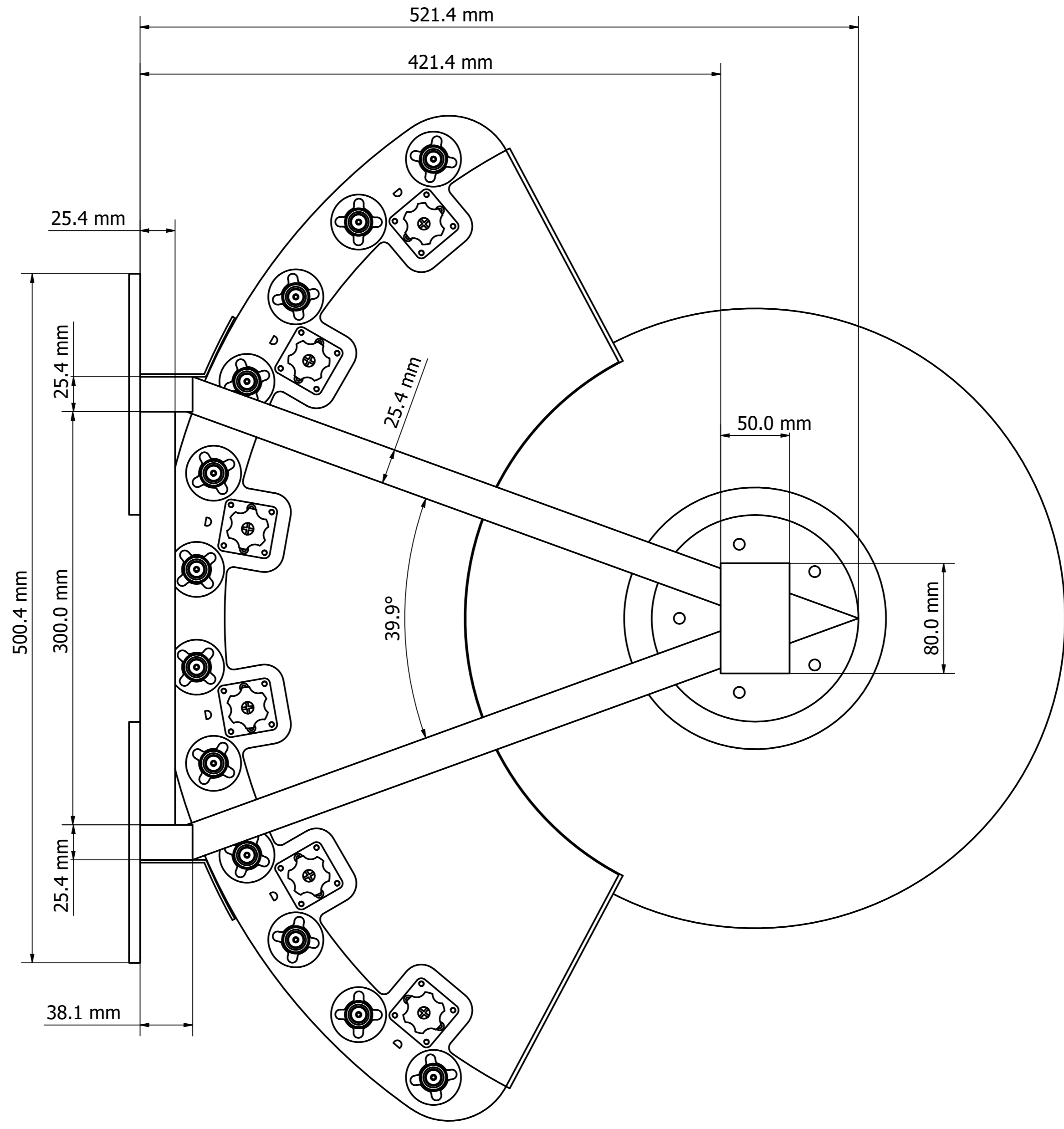

Designed by VIGNESH	Drawing by LAWRENCE	Date 8/2/2022	Approved by PAVEL	Date 10/2/2022	Quantity	Material
MATSING LENS TECHNOLOGY ENABLED						MS-6F45
MS-6F45 (mm)					Revision 1.0	Sheet 6 / 6