

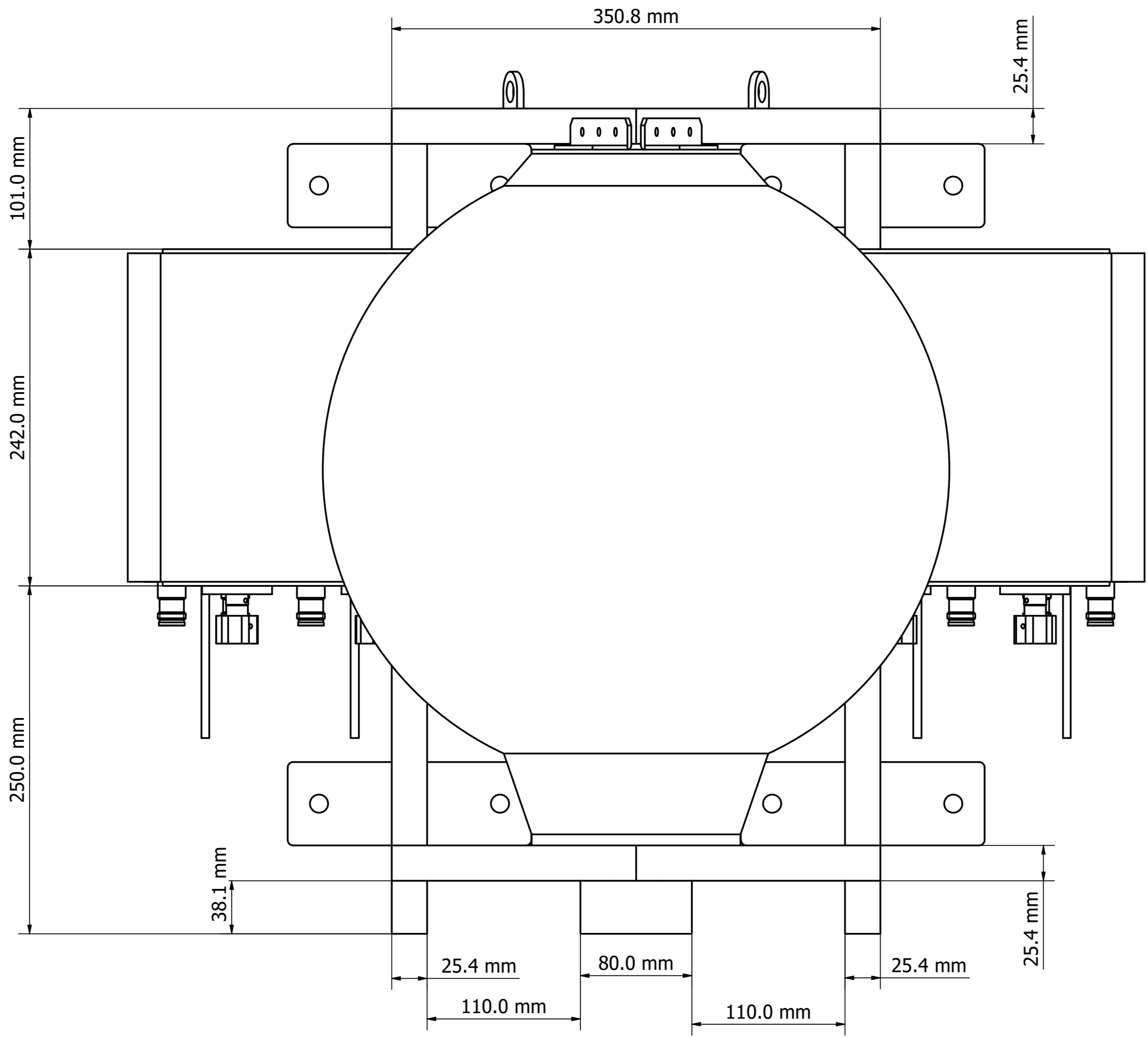



Designed by VIGNESH	Drawing by LAWRENCE	Date 10/8/2022	Approved by PAVEL	Date 22/8/2022	Quantity	Material
<b>MATSING</b> LENS TECHNOLOGY ENABLED						MS-6C45
MS-6C45 (mm)					Revision 1.0	Sheet 1 / 6



Designed by VIGNESH	Drawing by LAWRENCE	Date 10/8/2022	Approved by PAVEL	Date 22/8/2022	Quantity	Material
 <b>MATSING</b> <small>LENS TECHNOLOGY ENABLED</small>						MS-6C45
						MS-6C45 (mm)

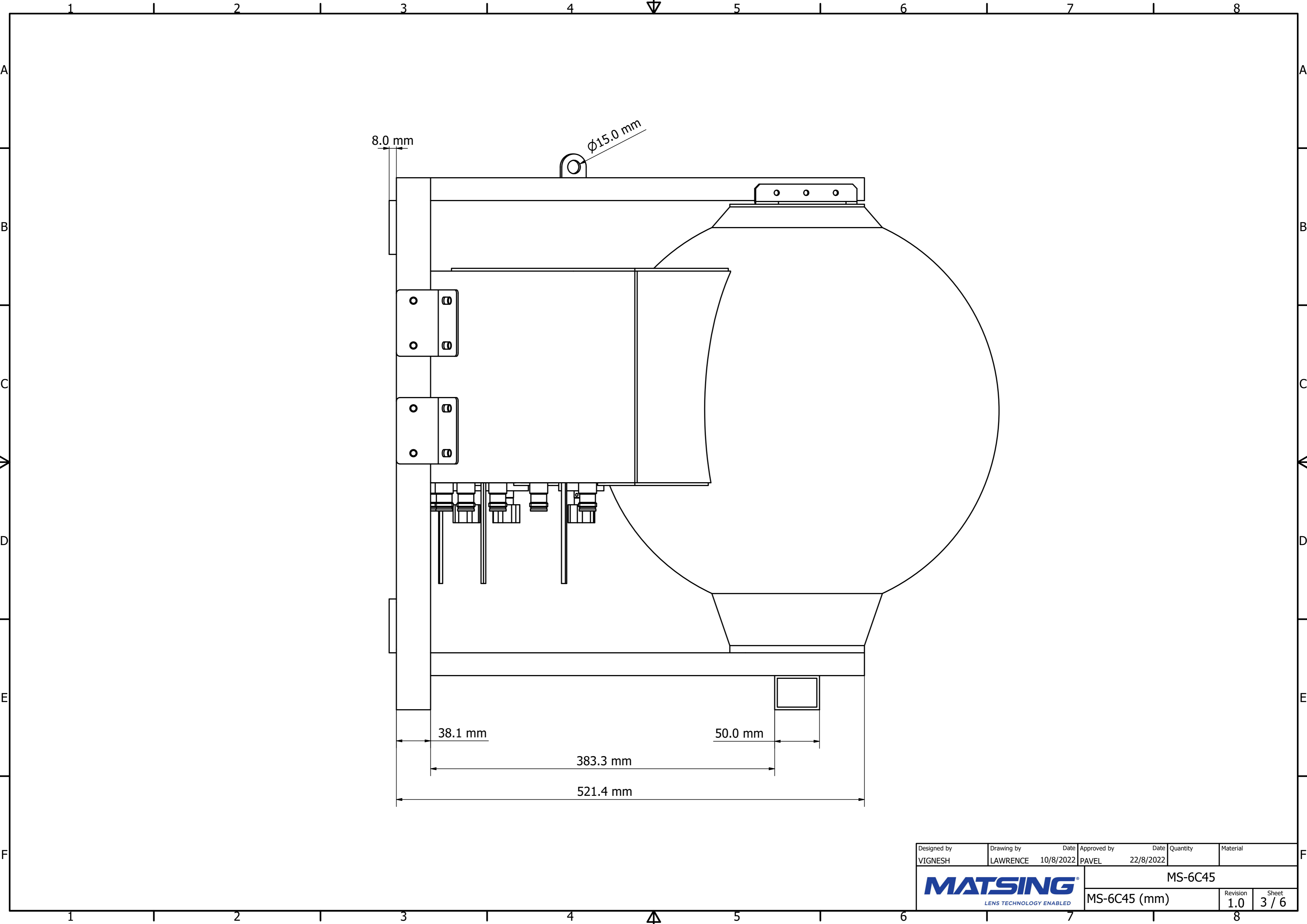

Designed by VIGNESH	Drawing by LAWRENCE	Date 10/8/2022	Approved by PAVEL	Date 22/8/2022	Quantity	Material
 <b>MATSING</b> <small>LENS TECHNOLOGY ENABLED</small>						MS-6C45
						MS-6C45 (mm)

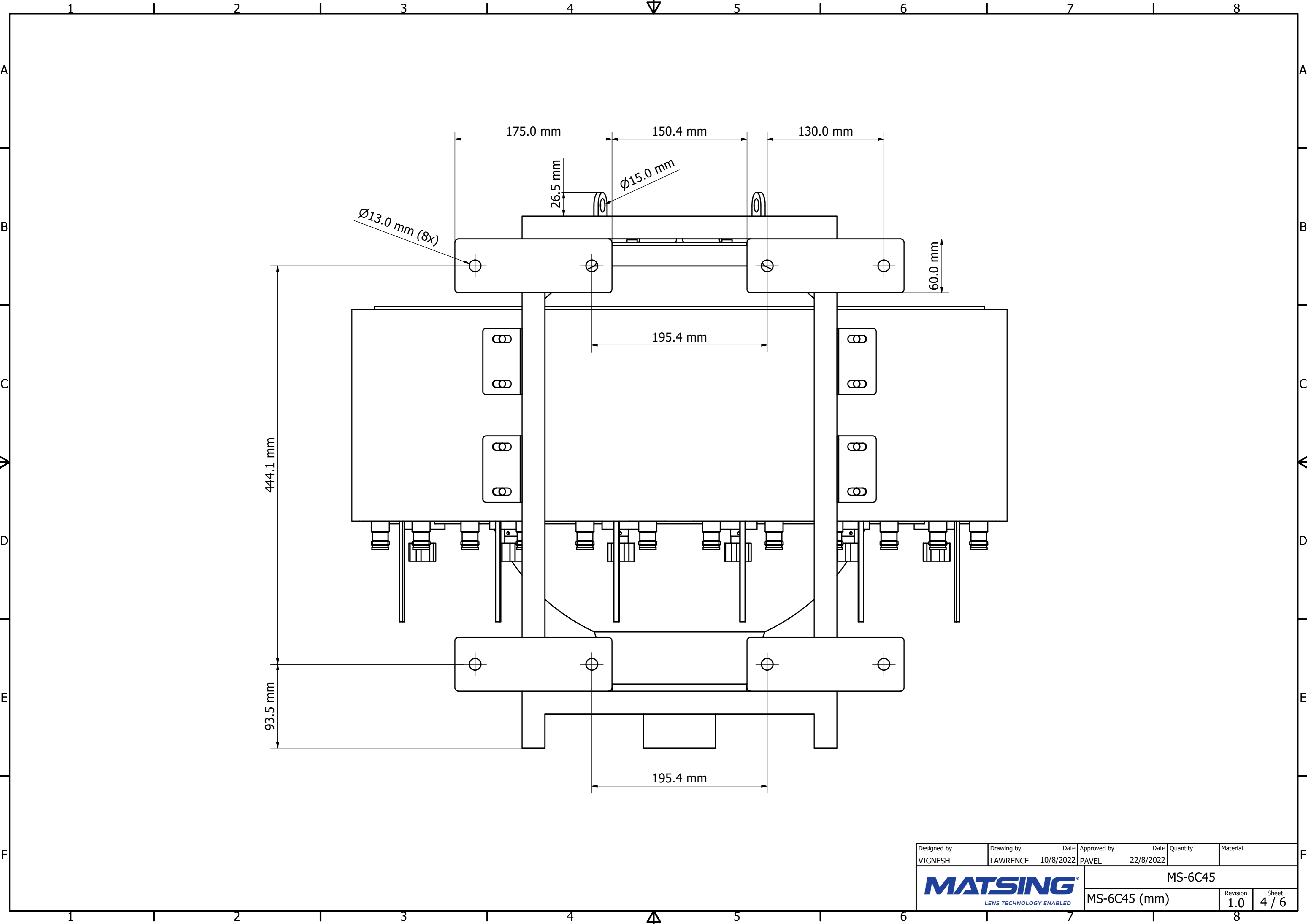

Designed by VIGNESH	Drawing by LAWRENCE	Date 10/8/2022	Approved by PAVEL	Date 22/8/2022	Quantity	Material
<b>MATSING</b> LENS TECHNOLOGY ENABLED						MS-6C45
MS-6C45 (mm)					Revision 1.0	Sheet 4 / 6

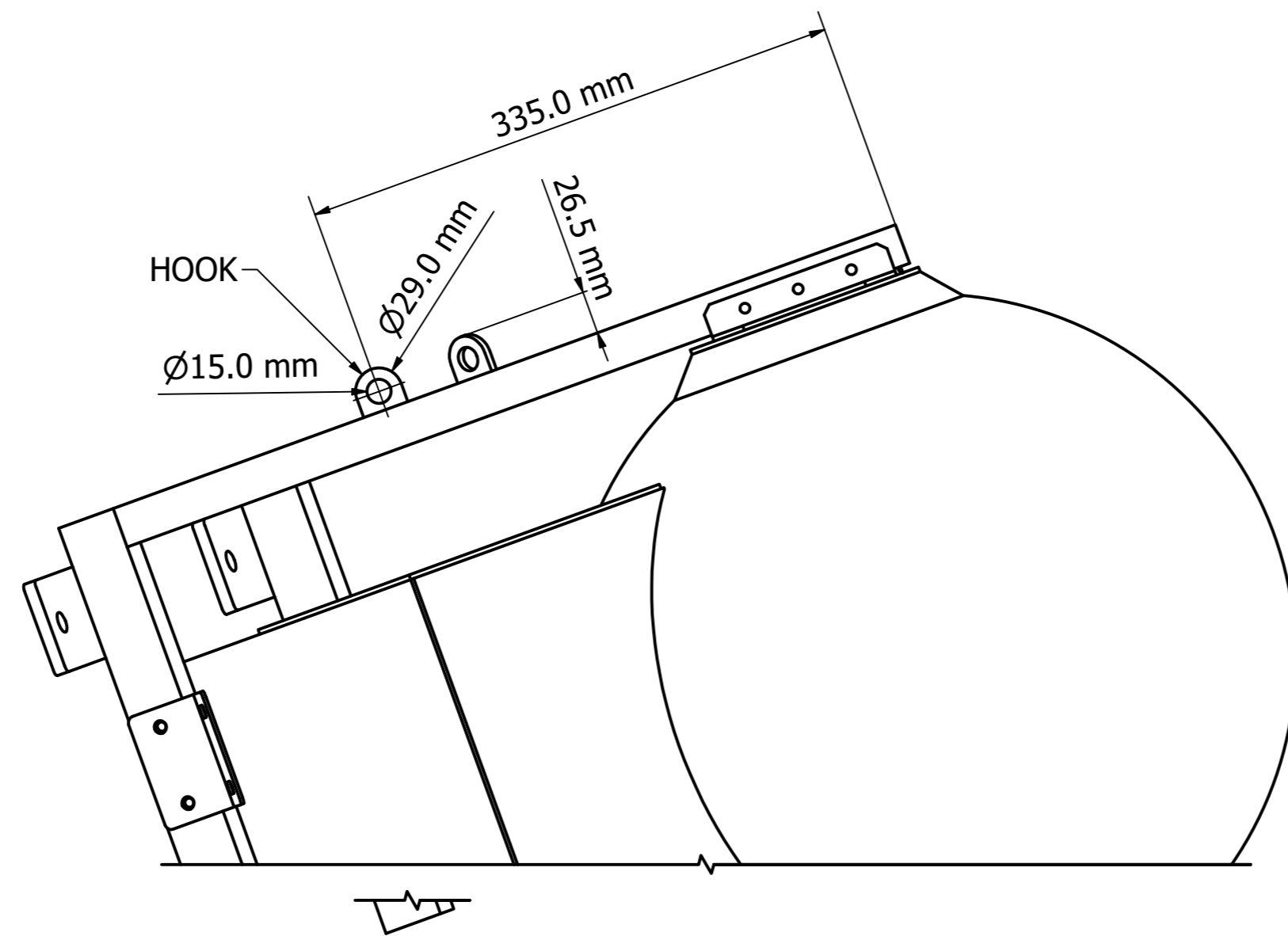

View A

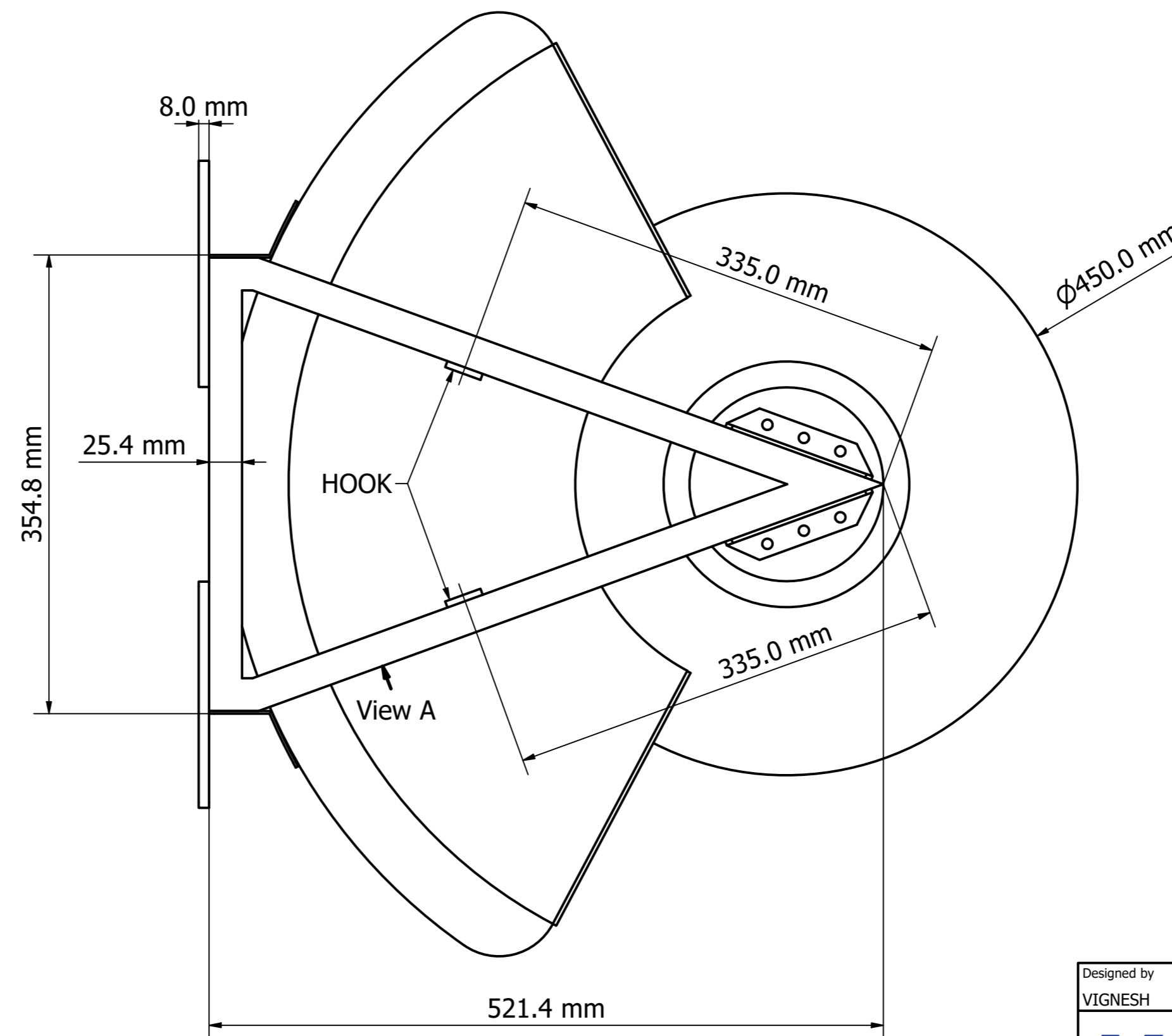

View A

Designed by VIGNESH	Drawing by LAWRENCE	Date 10/8/2022	Approved by PAVEL	Date 22/8/2022	Quantity	Material
<b>MATSING</b> LENS TECHNOLOGY ENABLED						MS-6C45
MS-6C45 (mm)					Revision 1.0	Sheet 5 / 6

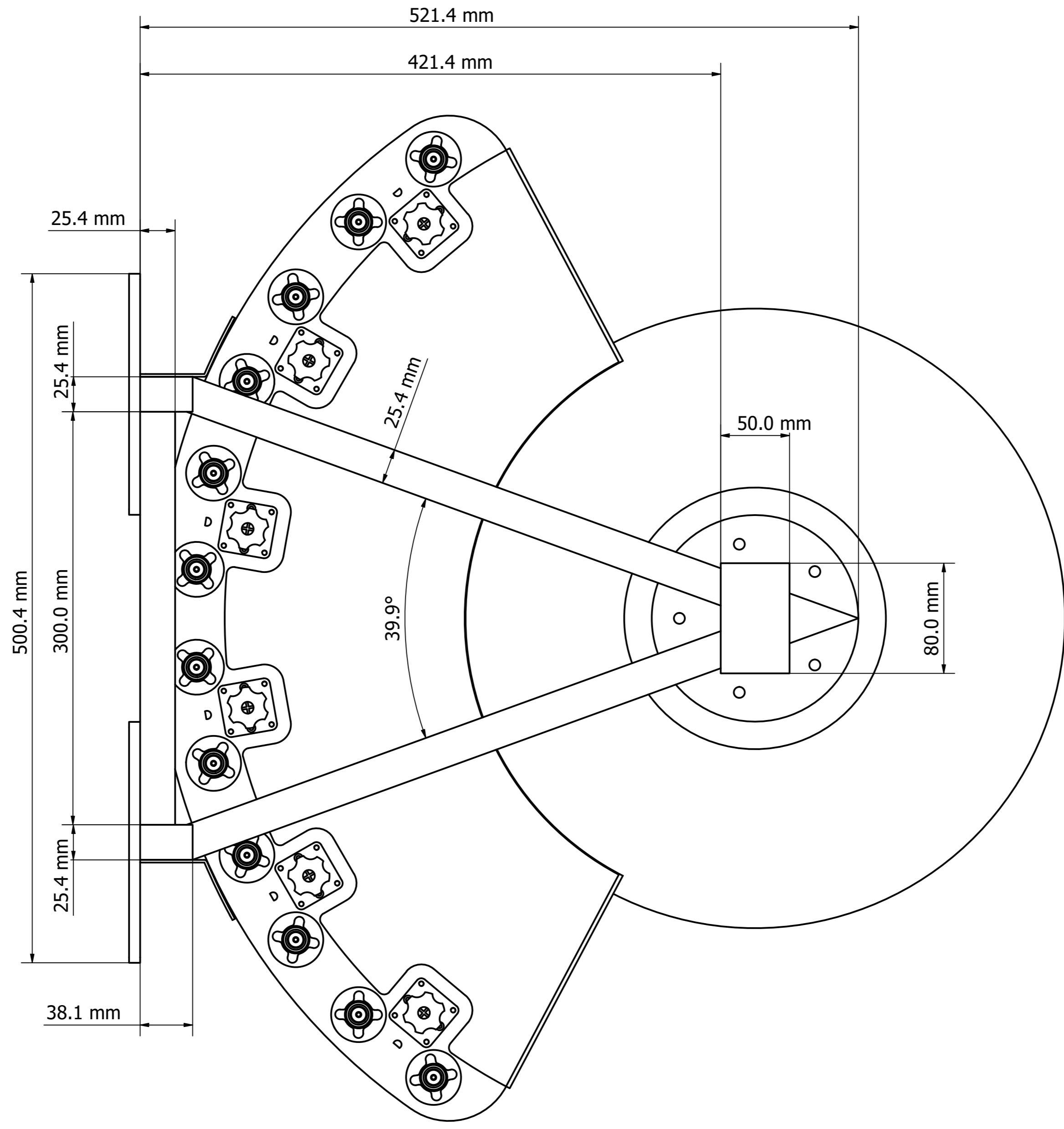

Designed by VIGNESH	Drawing by LAWRENCE	Date 10/8/2022	Approved by PAVEL	Date 22/8/2022	Quantity	Material
			MS-6C45			
			MS-6C45 (mm)			Revision 1.0