

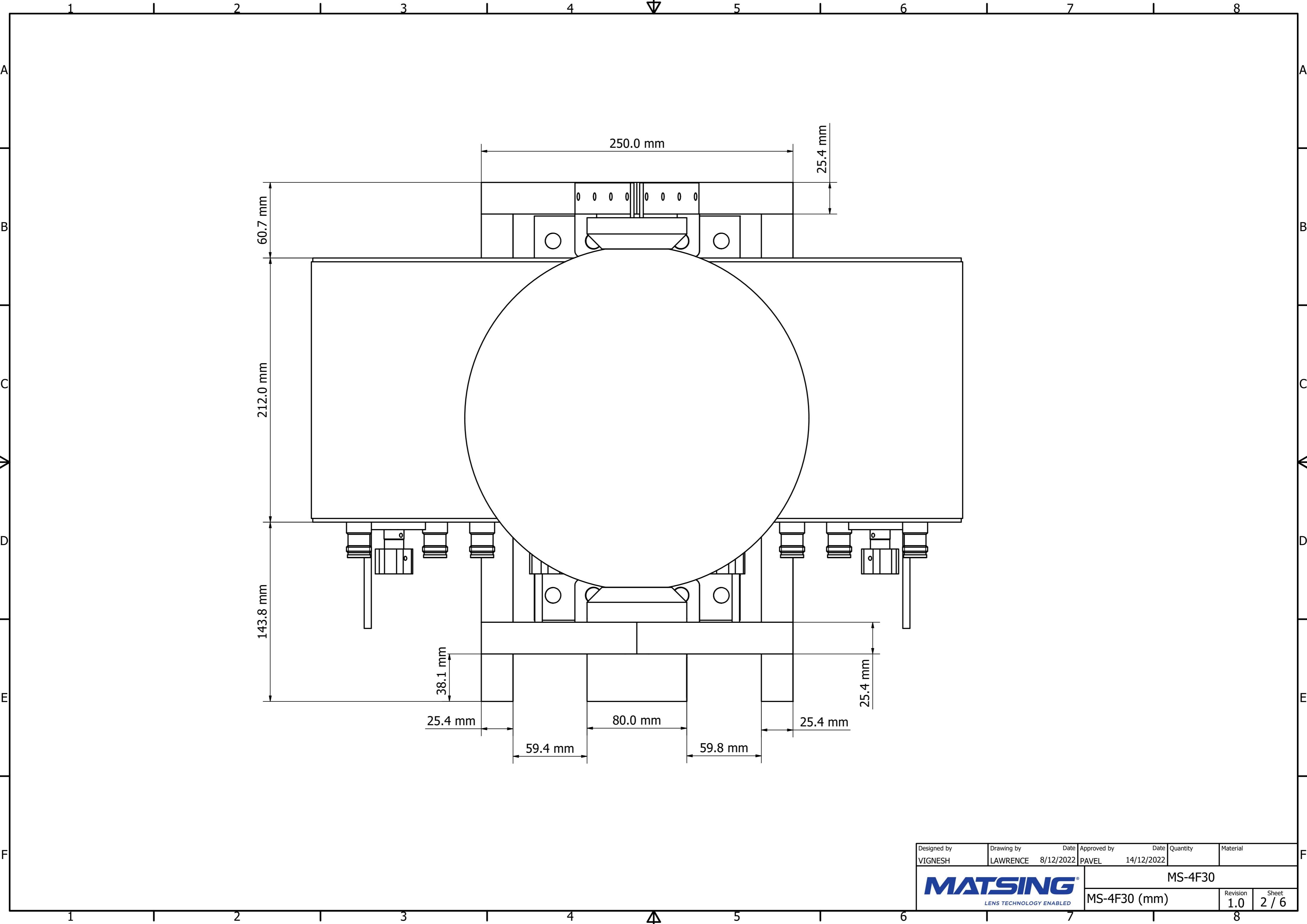



Designed by	Drawing by	Date	Approved by	Date	Quantity	Material
VIGNESH	LAWRENCE	8/12/2022	PAVEL	14/12/2022		
MATSING LENS TECHNOLOGY ENABLED						MS-4F30
						MS-4F30 (mm)
						Revision 1.0
						Sheet 1 / 6



Designed by VIGNESH	Drawing by LAWRENCE	Date 8/12/2022	Approved by PAVEL	Date 14/12/2022	Quantity	Material
						MS-4F30
						MS-4F30 (mm)

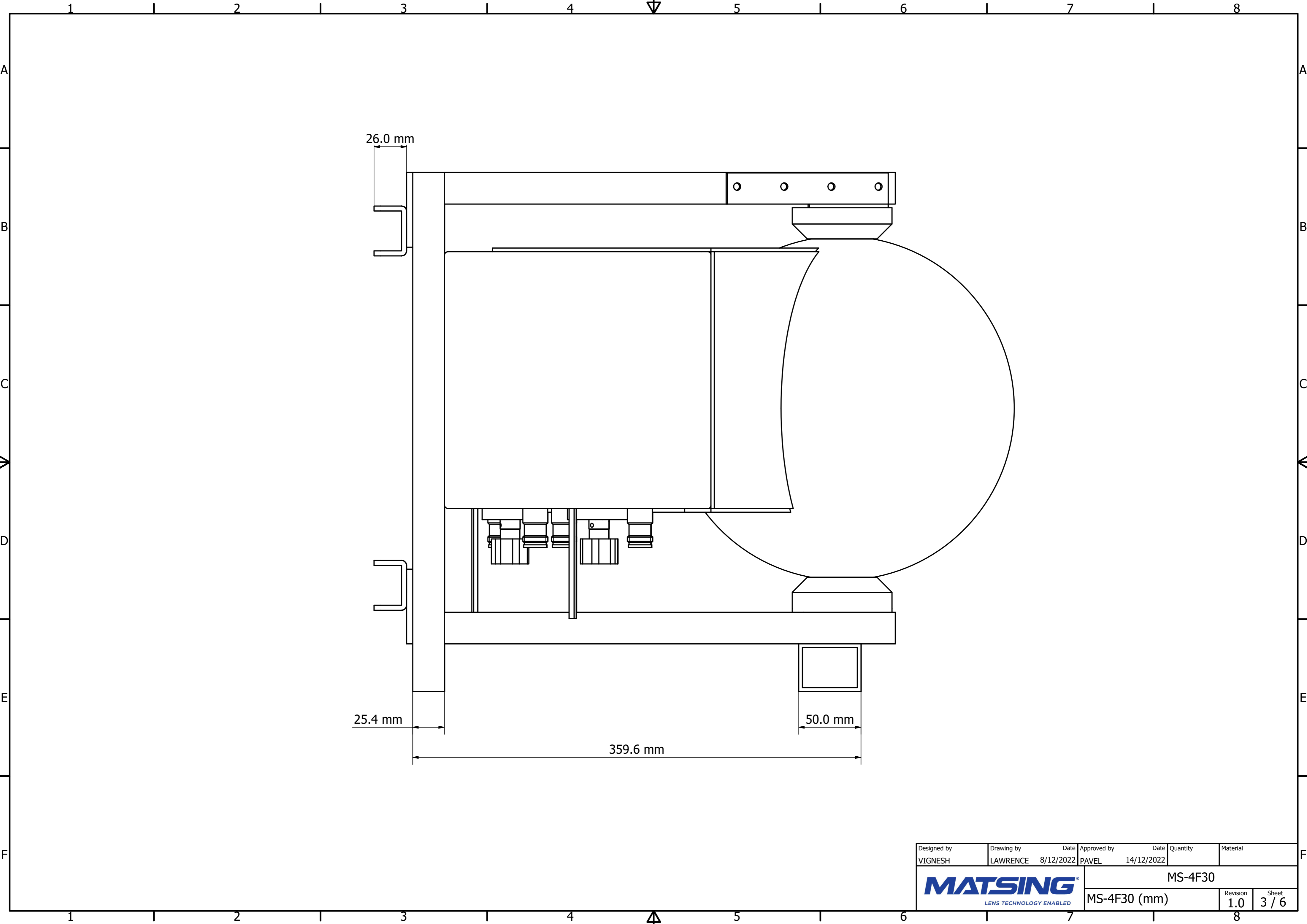

Designed by VIGNESH	Drawing by LAWRENCE	Date 8/12/2022	Approved by PAVEL	Date 14/12/2022	Quantity	Material
 MATSING <small>LENS TECHNOLOGY ENABLED</small>						MS-4F30
						MS-4F30 (mm)

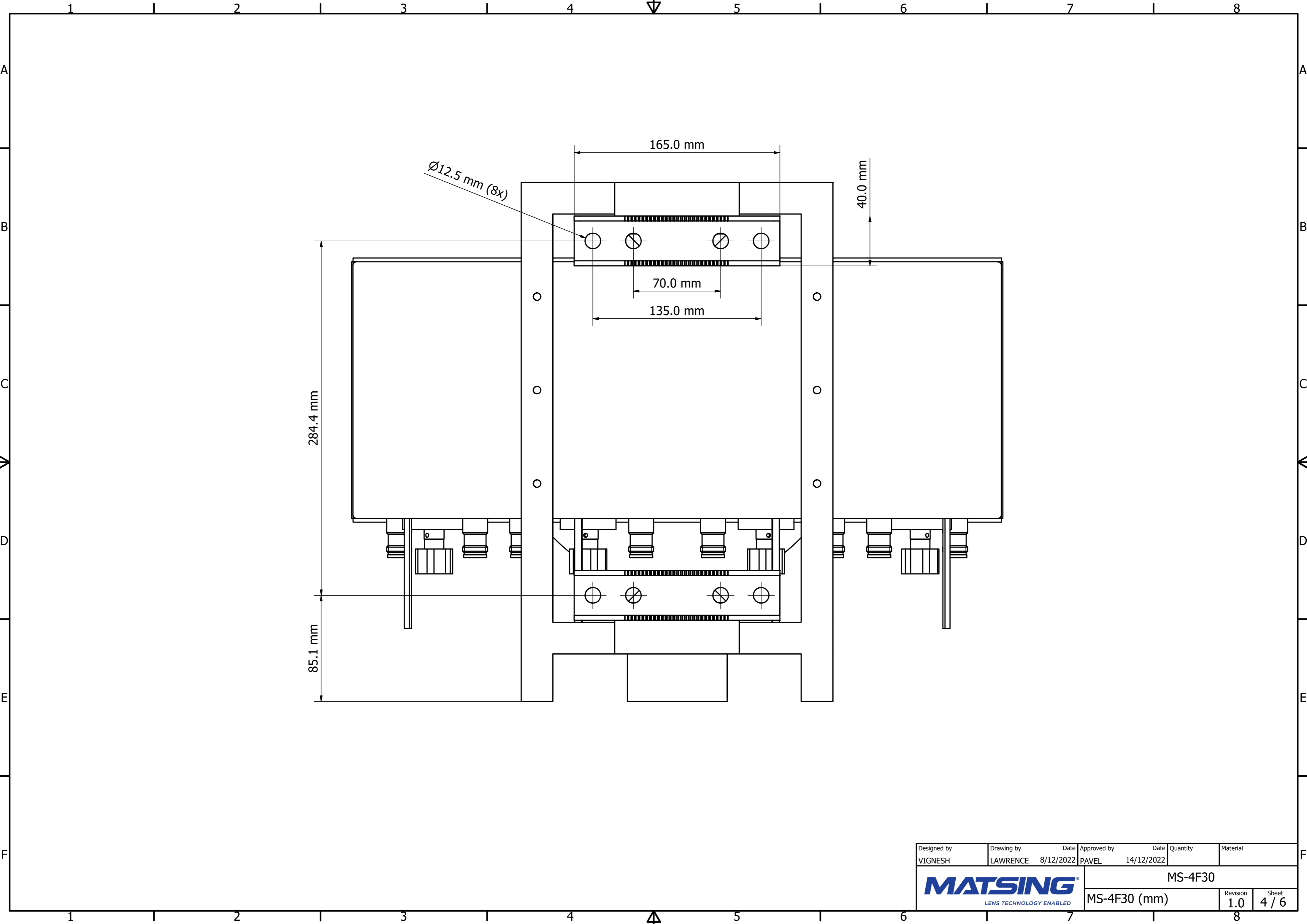

Designed by VIGNESH	Drawing by LAWRENCE	Date 8/12/2022	Approved by PAVEL	Date 14/12/2022	Quantity	Material
						MS-4F30
						MS-4F30 (mm)

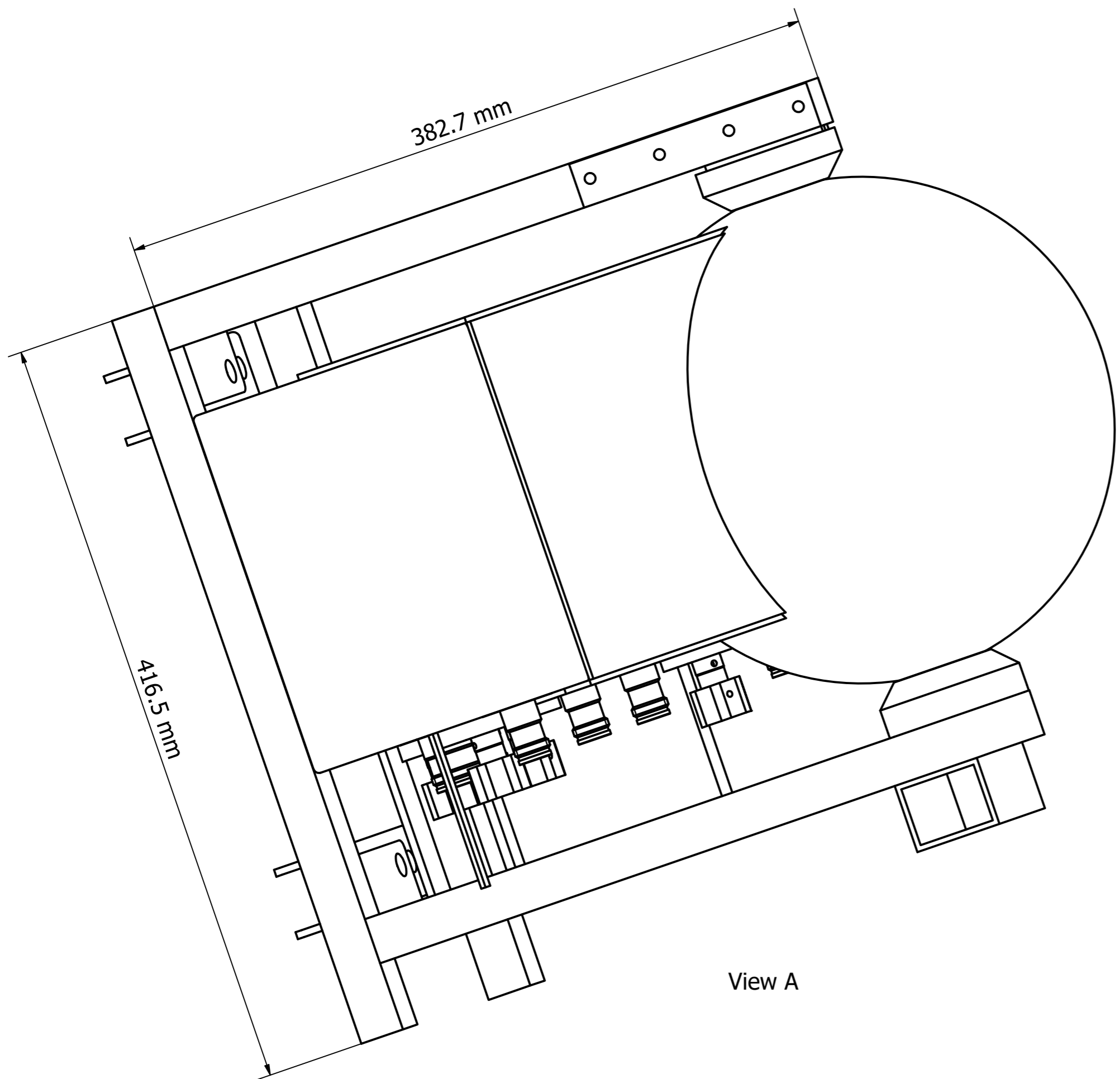

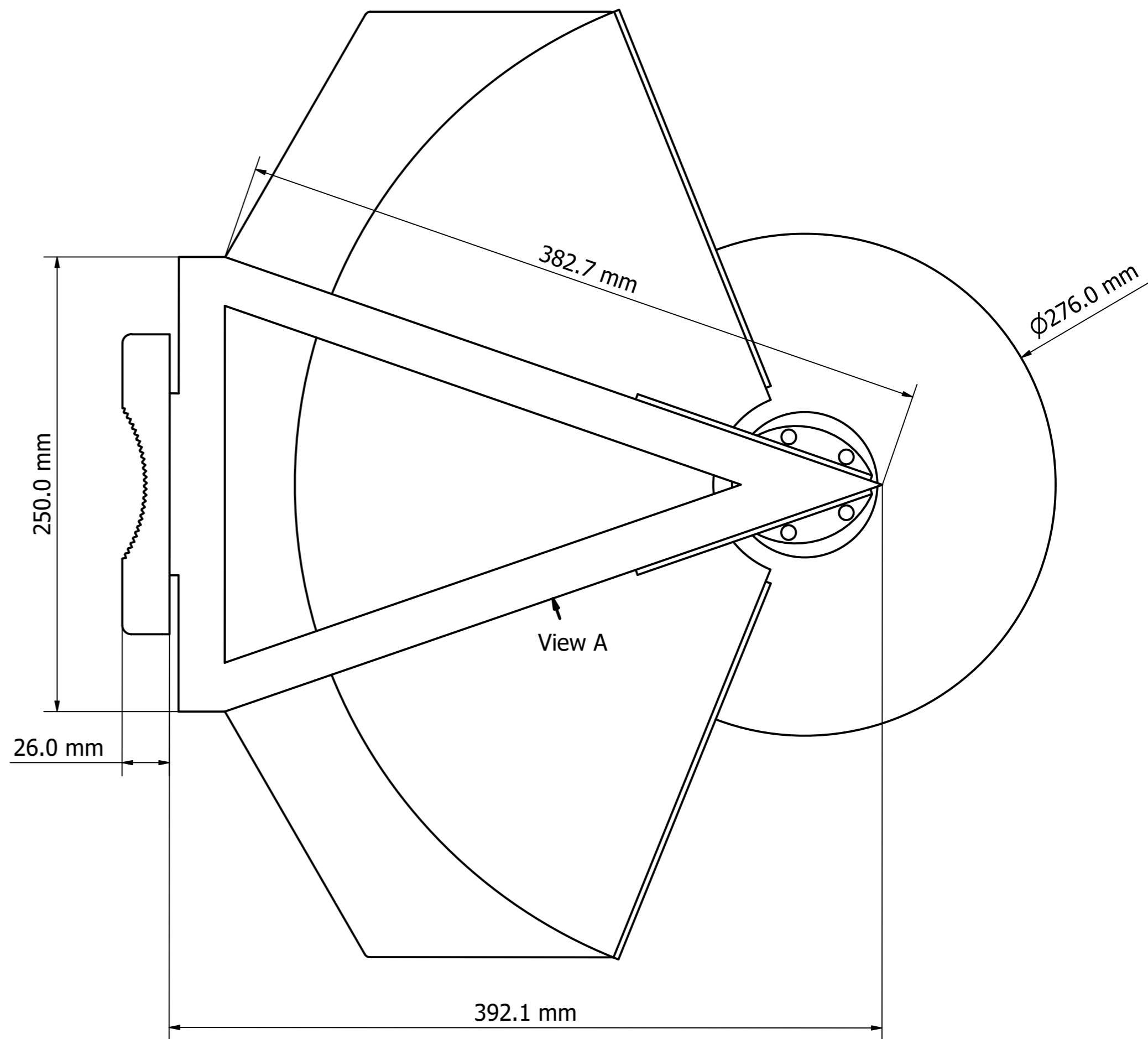

View A

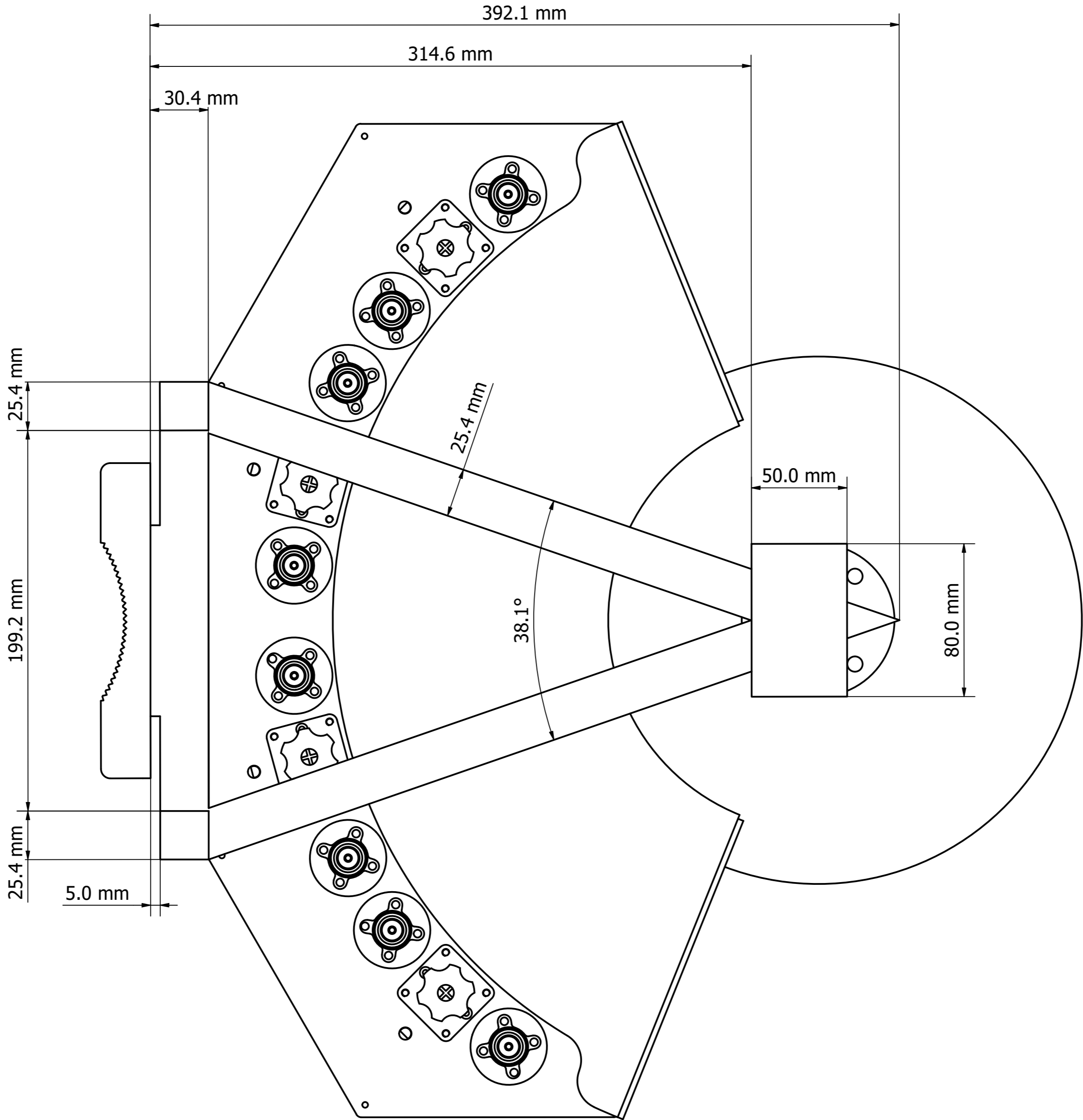
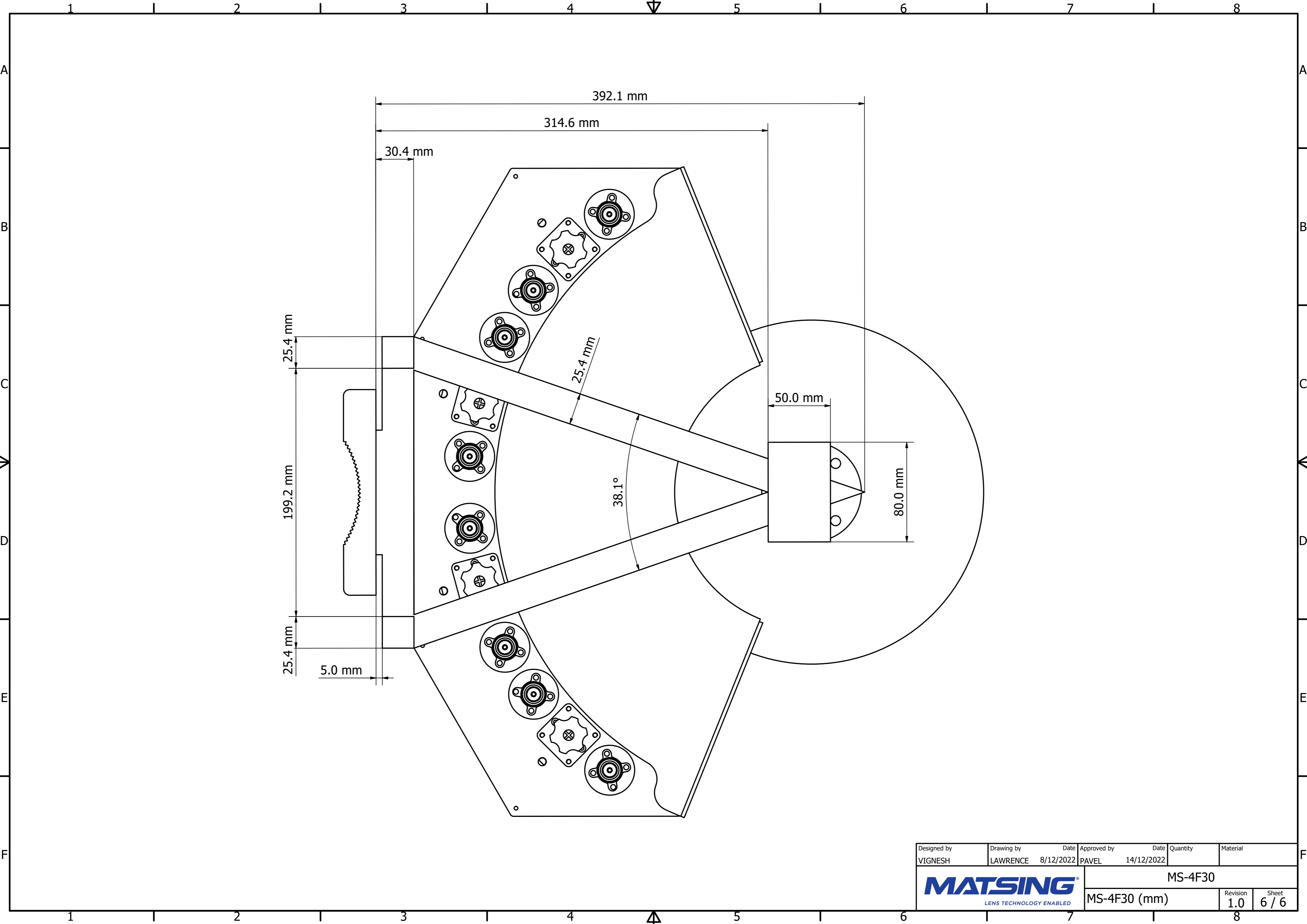

View A

Designed by VIGNESH	Drawing by LAWRENCE	Date 8/12/2022	Approved by PAVEL	Date 14/12/2022	Quantity	Material
						MS-4F30
						MS-4F30 (mm)



Designed by VIGNESH	Drawing by LAWRENCE	Date 8/12/2022	Approved by PAVEL	Date 14/12/2022	Quantity	Material
 MATSING <small>LENS TECHNOLOGY ENABLED</small>						MS-4F30
						MS-4F30 (mm)