

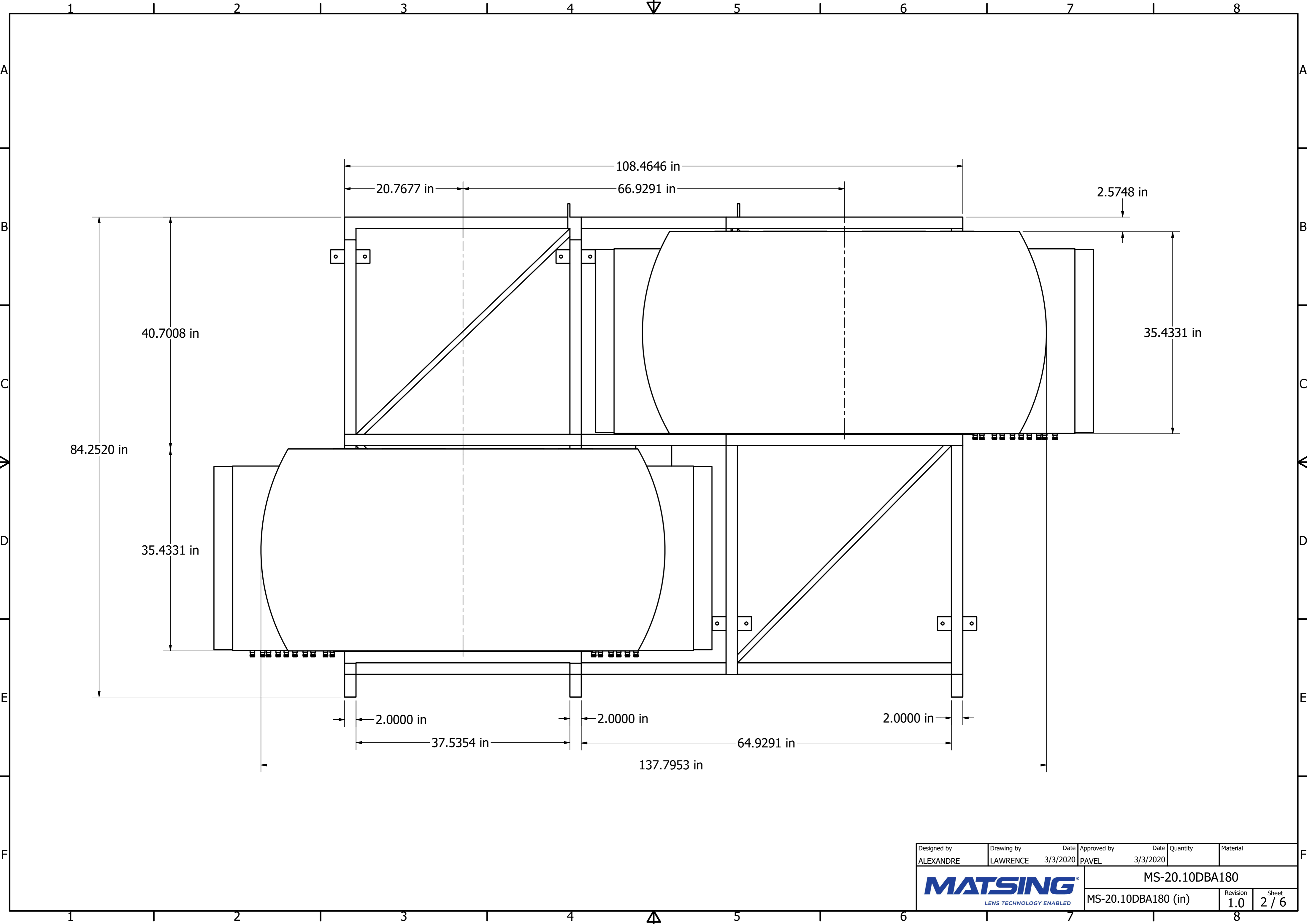



Designed by	Drawing by	Date	Approved by	Date	Quantity	Material
ALEXANDRE	LAWRENCE	3/3/2020	PAVEL	3/3/2020		
MATSING						MS-20.10DBA180
LENS TECHNOLOGY ENABLED						MS-20.10DBA180 (in)
					Revision	Sheet
					1.0	1 / 6



Designed by ALEXANDRE	Drawing by LAWRENCE	Date 3/3/2020	Approved by PAVEL	Date 3/3/2020	Quantity	Material
 MATSING <small>LENS TECHNOLOGY ENABLED</small>						MS-20.10DBA180
						MS-20.10DBA180 (in)

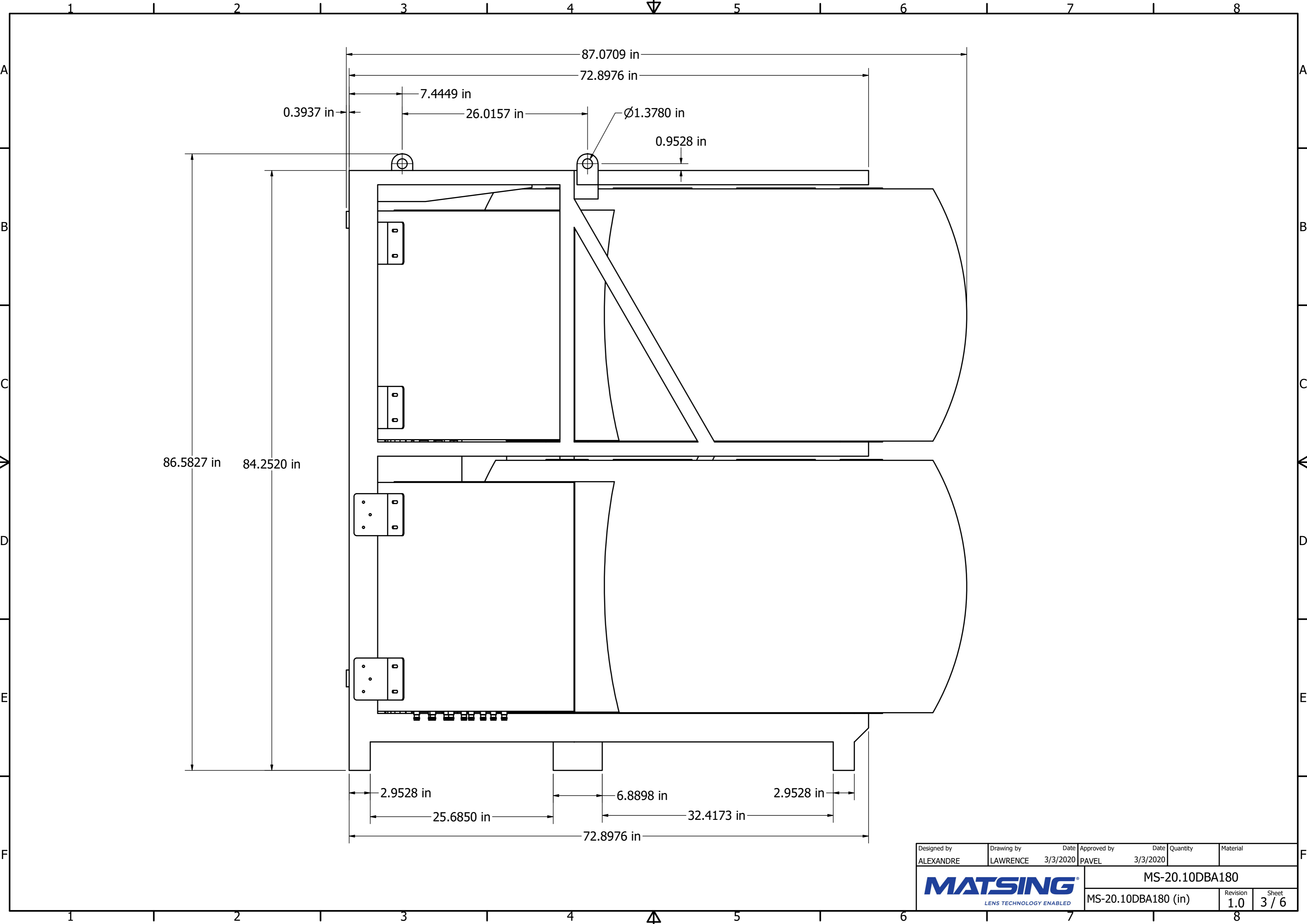

Designed by	Drawing by	Date	Approved by	Date	Quantity	Material
ALEXANDRE	LAWRENCE	3/3/2020	PAVEL	3/3/2020		
						MS-20.10DBA180
						MS-20.10DBA180 (in)

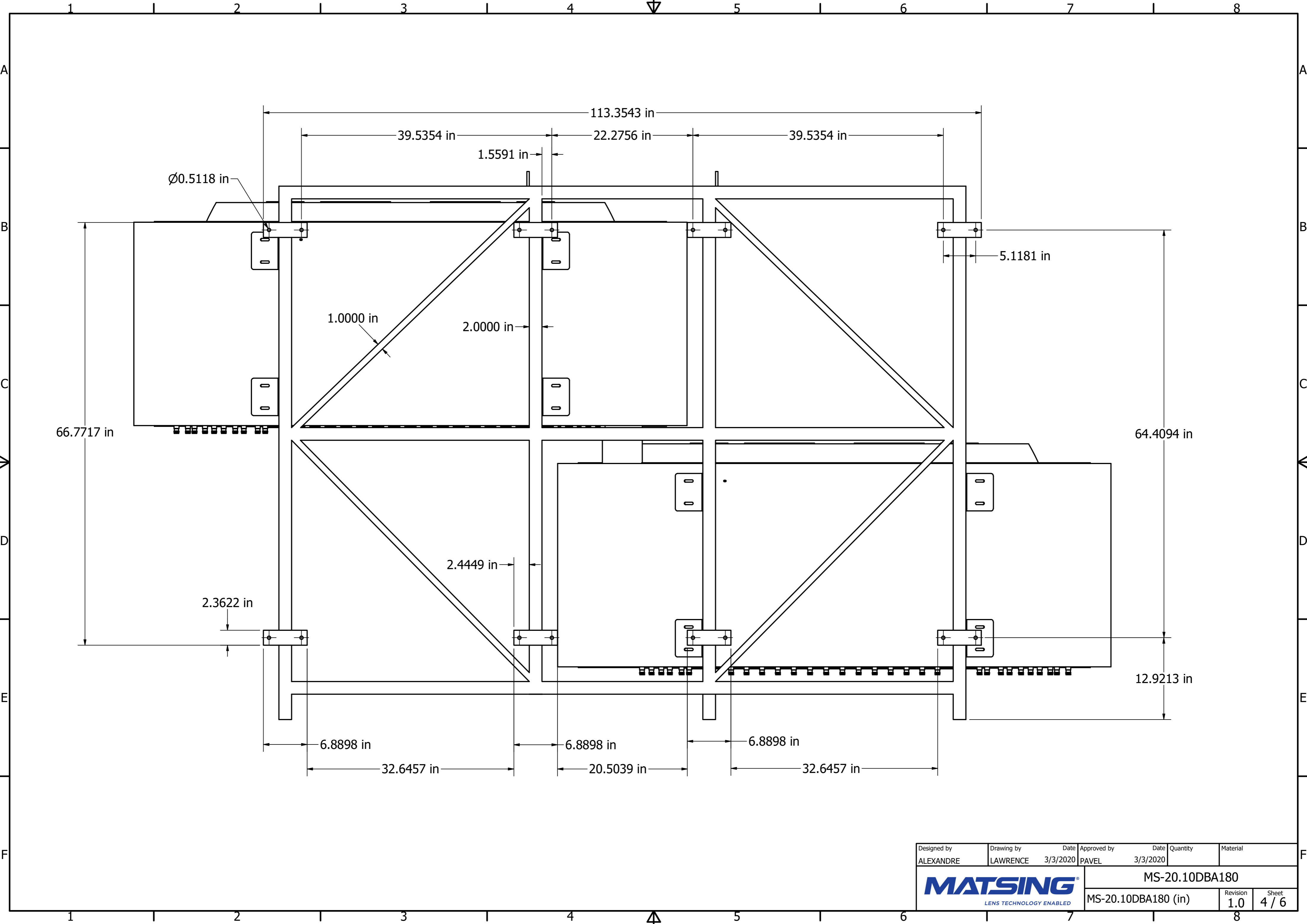

Designed by ALEXANDRE	Drawing by LAWRENCE	Date 3/3/2020	Approved by PAVEL	Date 3/3/2020	Quantity	Material
MATSING LENS TECHNOLOGY ENABLED						MS-20.10DBA180
MS-20.10DBA180 (in)					Revision 1.0	Sheet 4 / 6

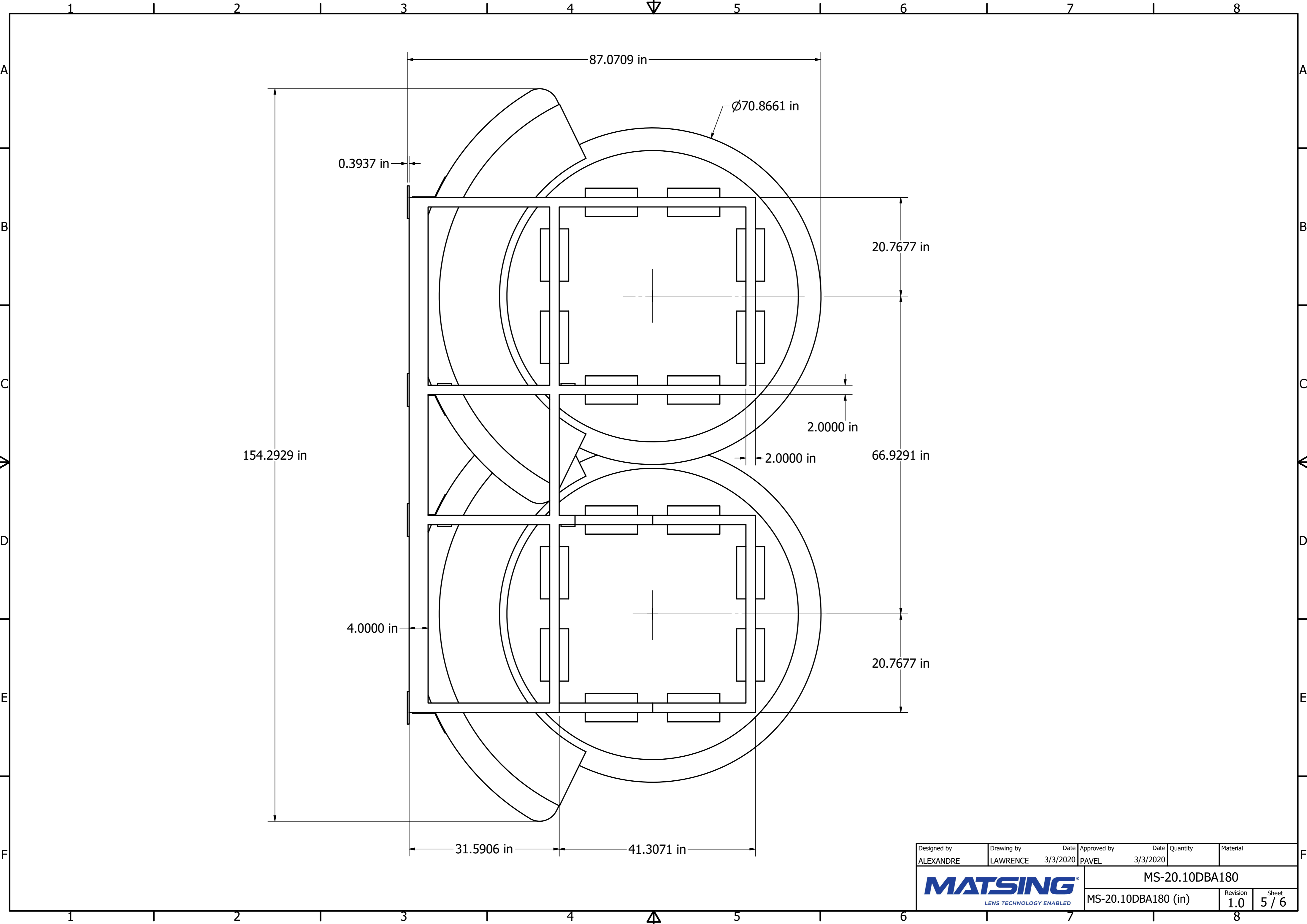

Designed by ALEXANDRE	Drawing by LAWRENCE	Date 3/3/2020	Approved by PAVEL	Date 3/3/2020	Quantity	Material
 MATSING <small>LENS TECHNOLOGY ENABLED</small>						MS-20.10DBA180
						MS-20.10DBA180 (in)

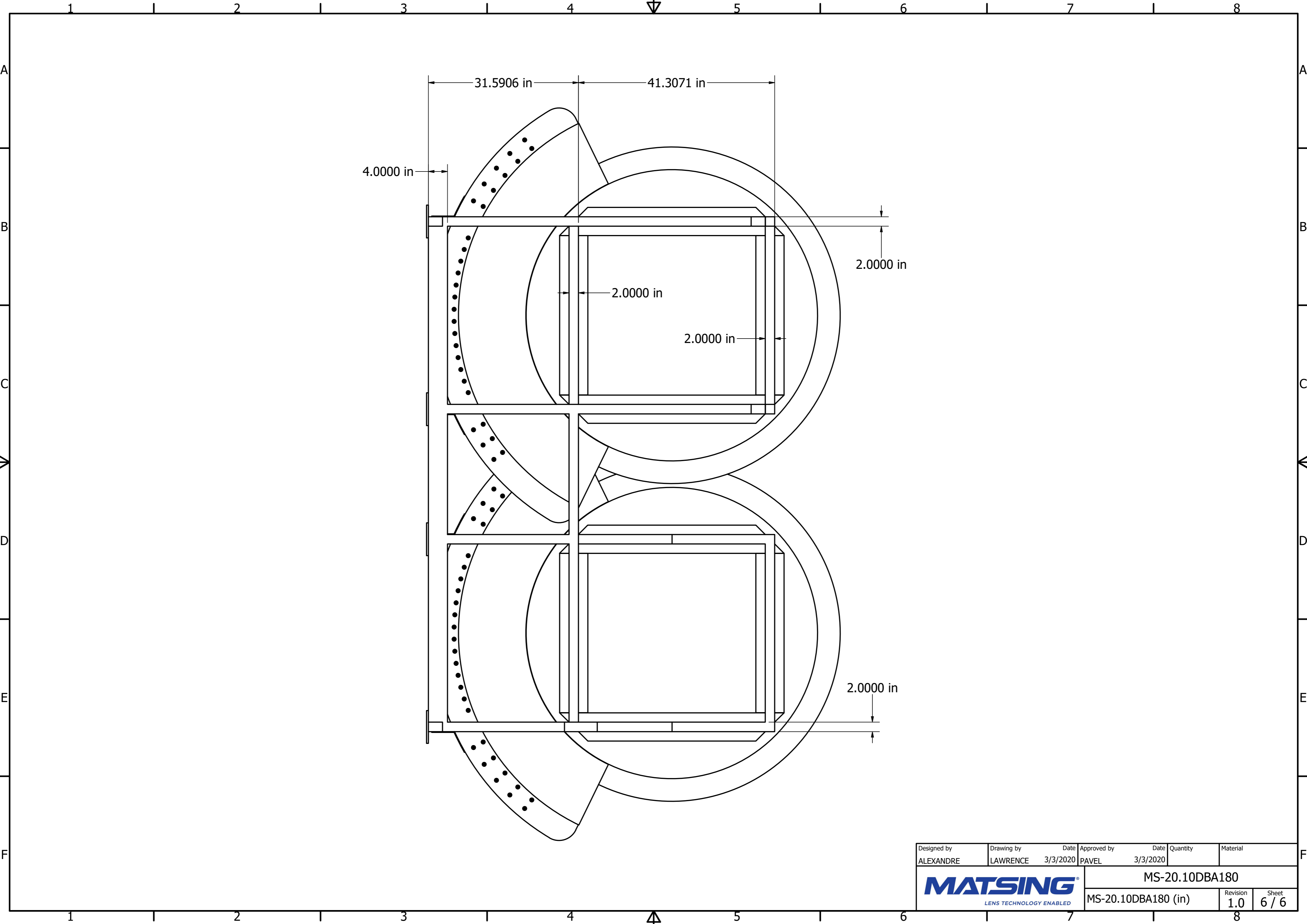

Designed by	Drawing by	Date	Approved by	Date	Quantity	Material
ALEXANDRE	LAWRENCE	3/3/2020	PAVEL	3/3/2020		
						MS-20.10DBA180
						MS-20.10DBA180 (in)