

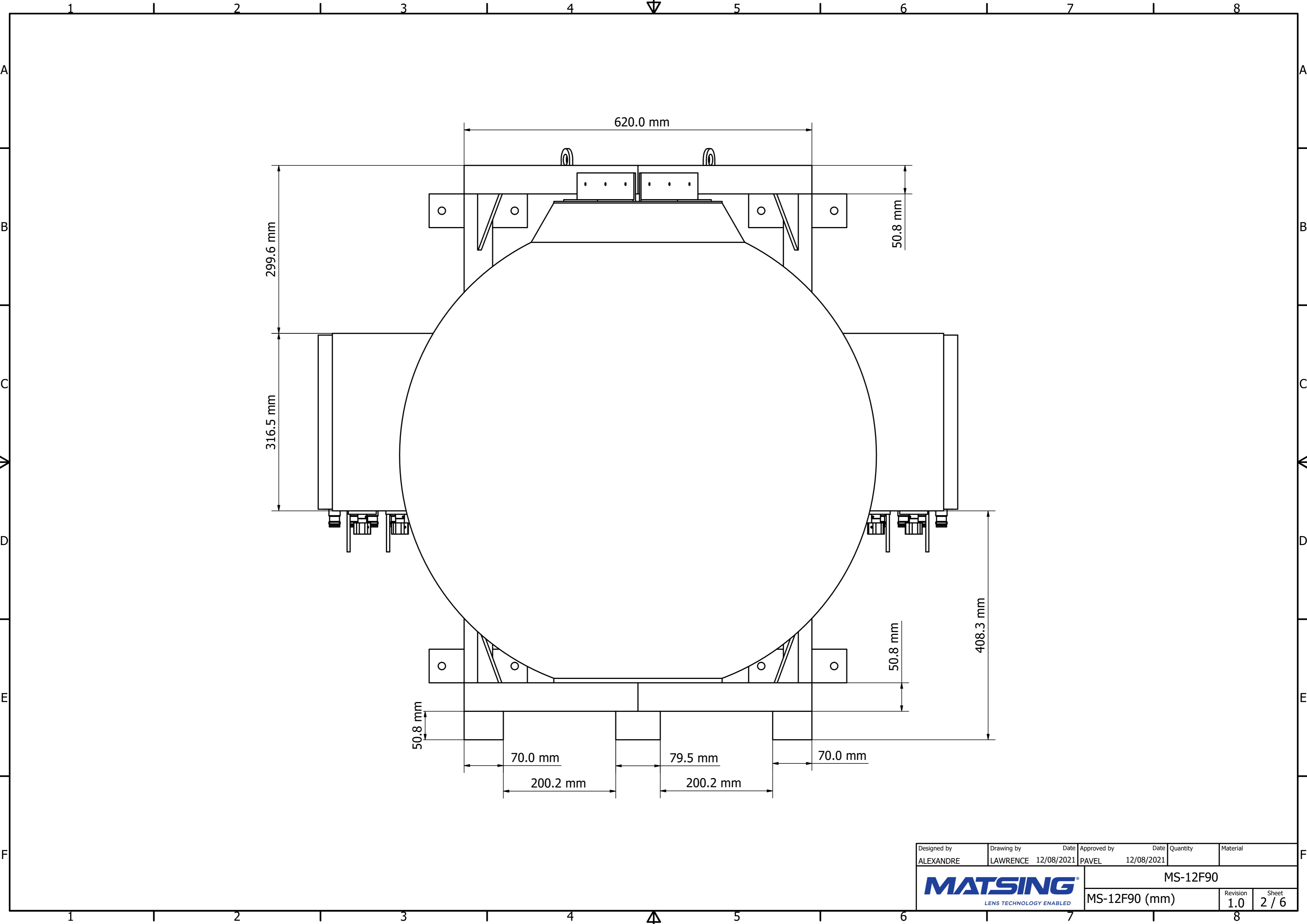

Designed by	Drawing by	Date	Approved by	Date	Quantity	Material
ALEXANDRE	LAWRENCE	12/08/2021	PAVEL	12/08/2021		
MATSING LENS TECHNOLOGY ENABLED						MS-12F90
						MS-12F90 (mm)
						Revision 1.0
						Sheet 1 / 6



Designed by ALEXANDRE	Drawing by LAWRENCE	Date 12/08/2021	Approved by PAVEL	Date 12/08/2021	Quantity	Material
 MATSING <small>LENS TECHNOLOGY ENABLED</small>						MS-12F90
						MS-12F90 (mm)

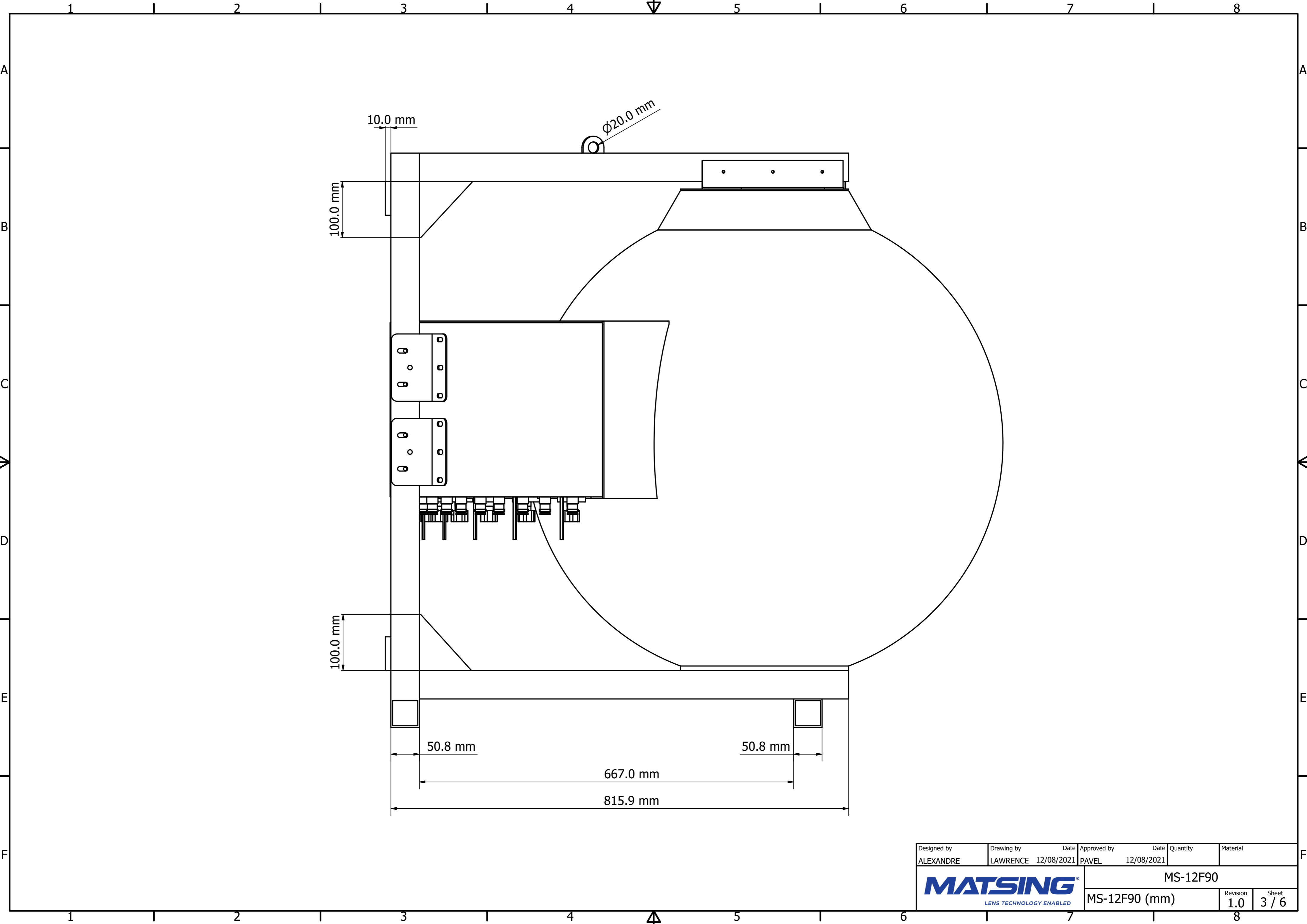

Designed by ALEXANDRE	Drawing by LAWRENCE	Date 12/08/2021	Approved by PAVEL	Date 12/08/2021	Quantity	Material
MATSING LENS TECHNOLOGY ENABLED						MS-12F90
MS-12F90 (mm)					Revision 1.0	Sheet 3 / 6

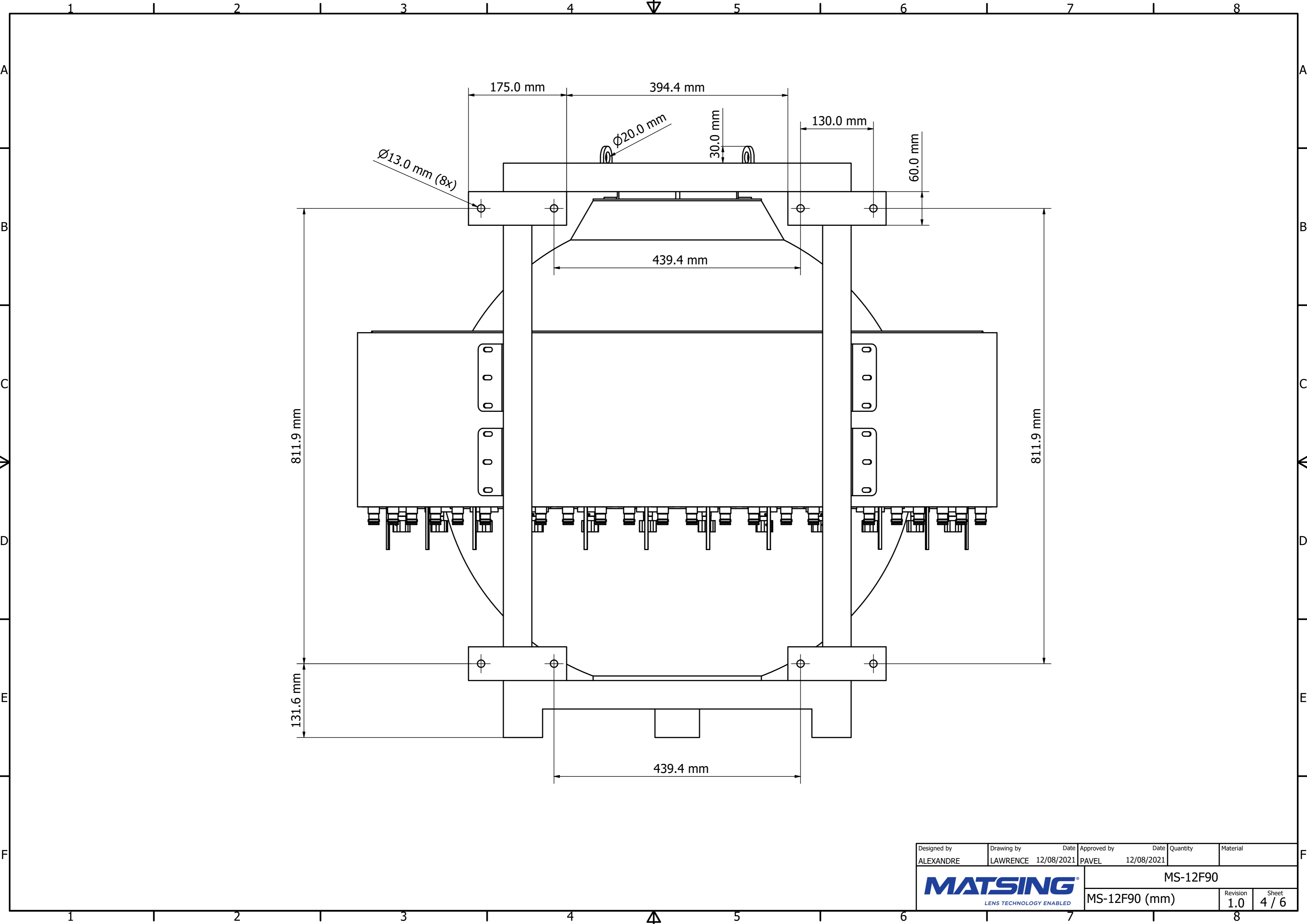

Designed by ALEXANDRE	Drawing by LAWRENCE	Date 12/08/2021	Approved by PAVEL	Date 12/08/2021	Quantity	Material
MATSING LENS TECHNOLOGY ENABLED						MS-12F90
MS-12F90 (mm)					Revision 1.0	Sheet 4 / 6

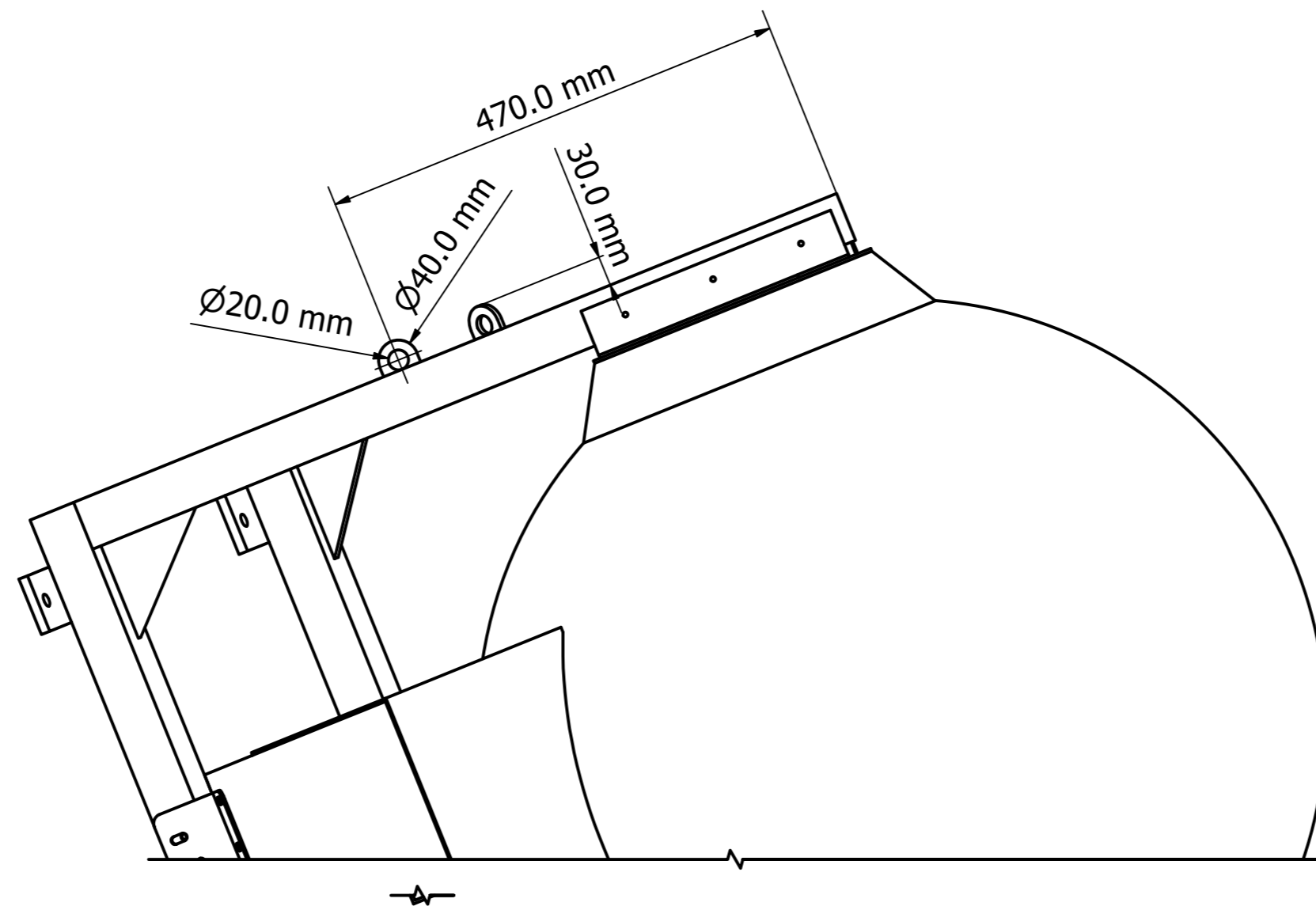

View A

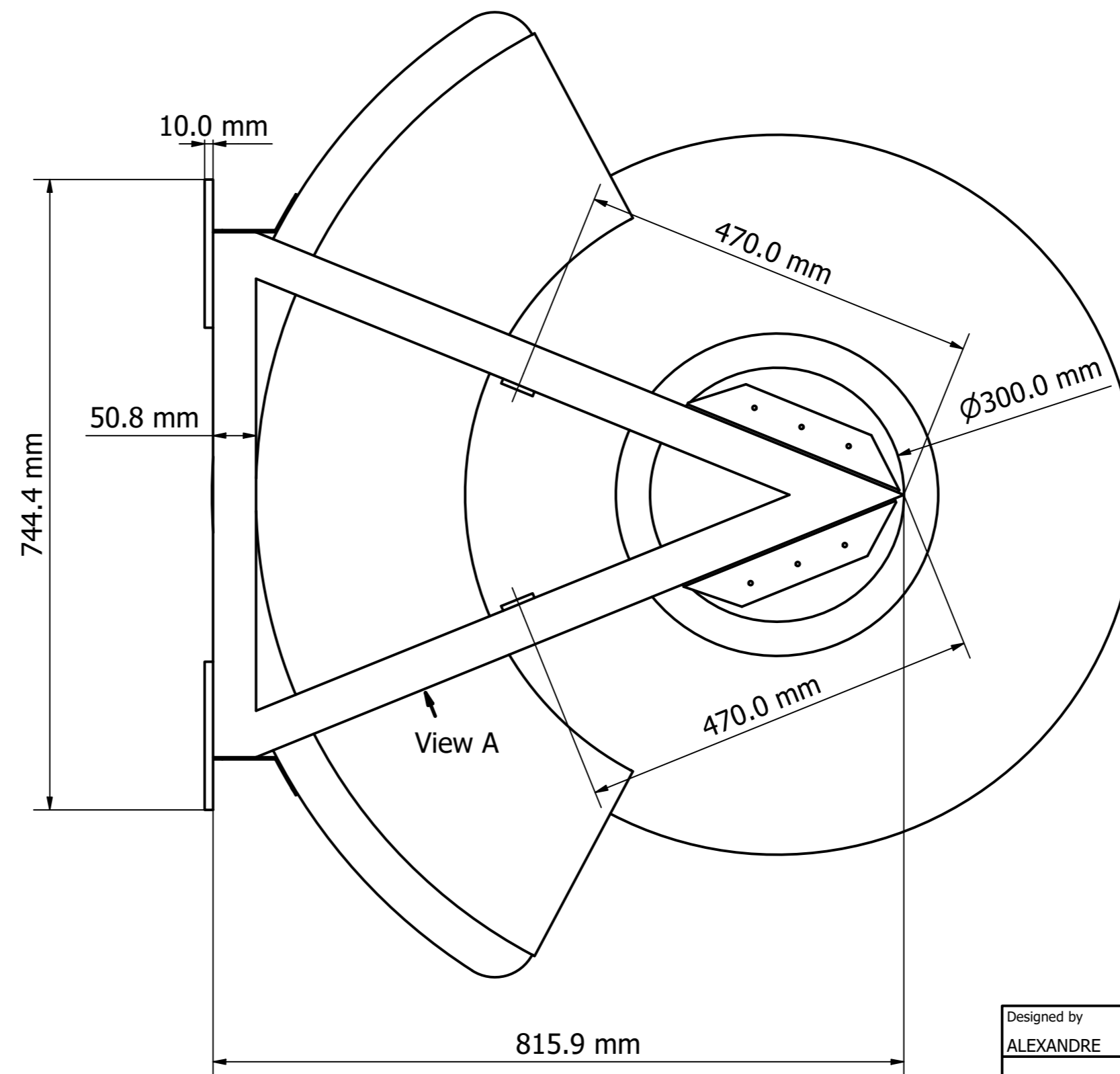

Designed by ALEXANDRE	Drawing by LAWRENCE	Date 12/08/2021	Approved by PAVEL	Date 12/08/2021	Quantity	Material
MATSING LENS TECHNOLOGY ENABLED						MS-12F90
MS-12F90 (mm)					Revision 1.0	Sheet 5 / 6

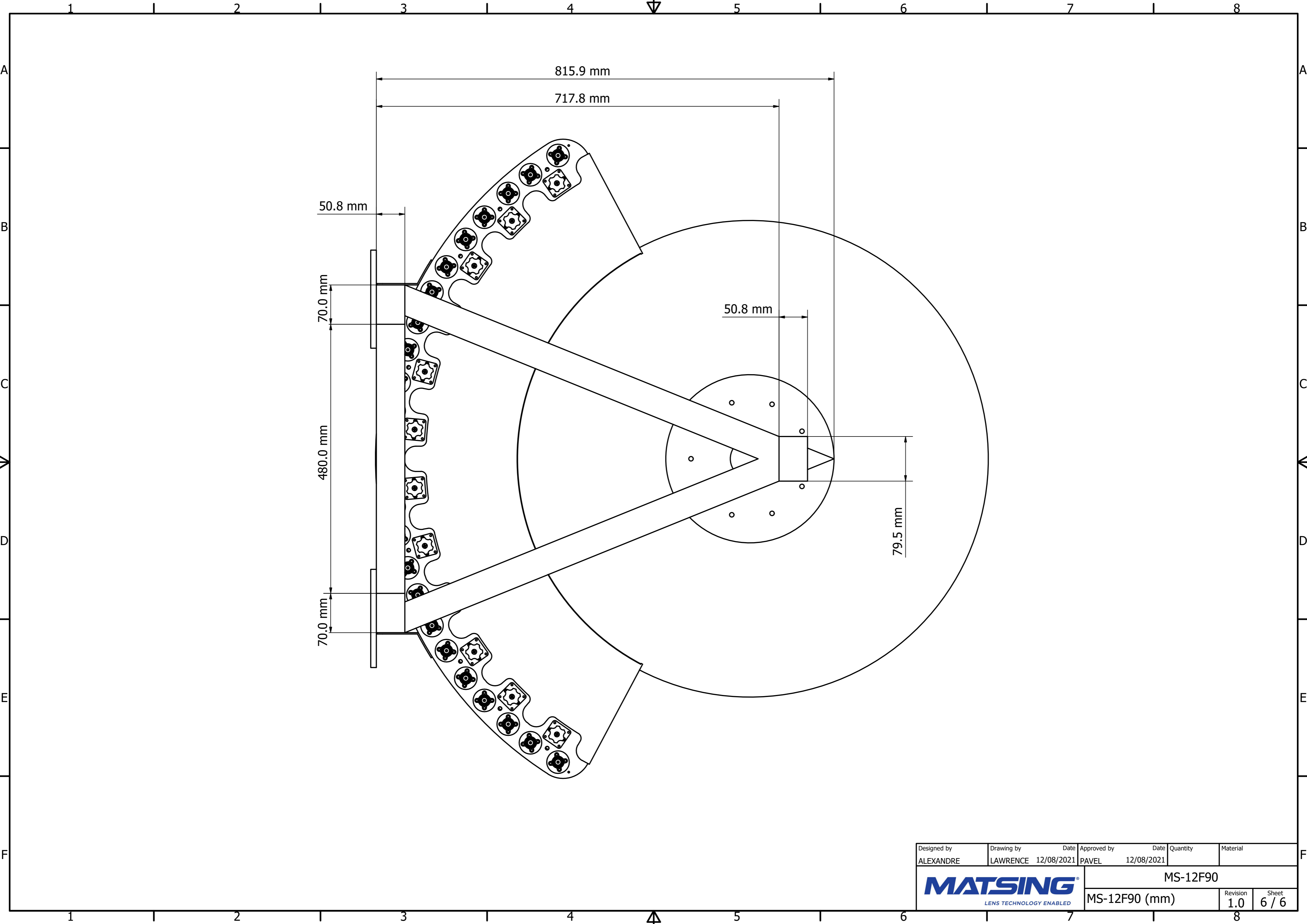

Designed by ALEXANDRE	Drawing by LAWRENCE	Date 12/08/2021	Approved by PAVEL	Date 12/08/2021	Quantity	Material
MATSING LENS TECHNOLOGY ENABLED						MS-12F90
MS-12F90 (mm)					Revision 1.0	Sheet 6 / 6