

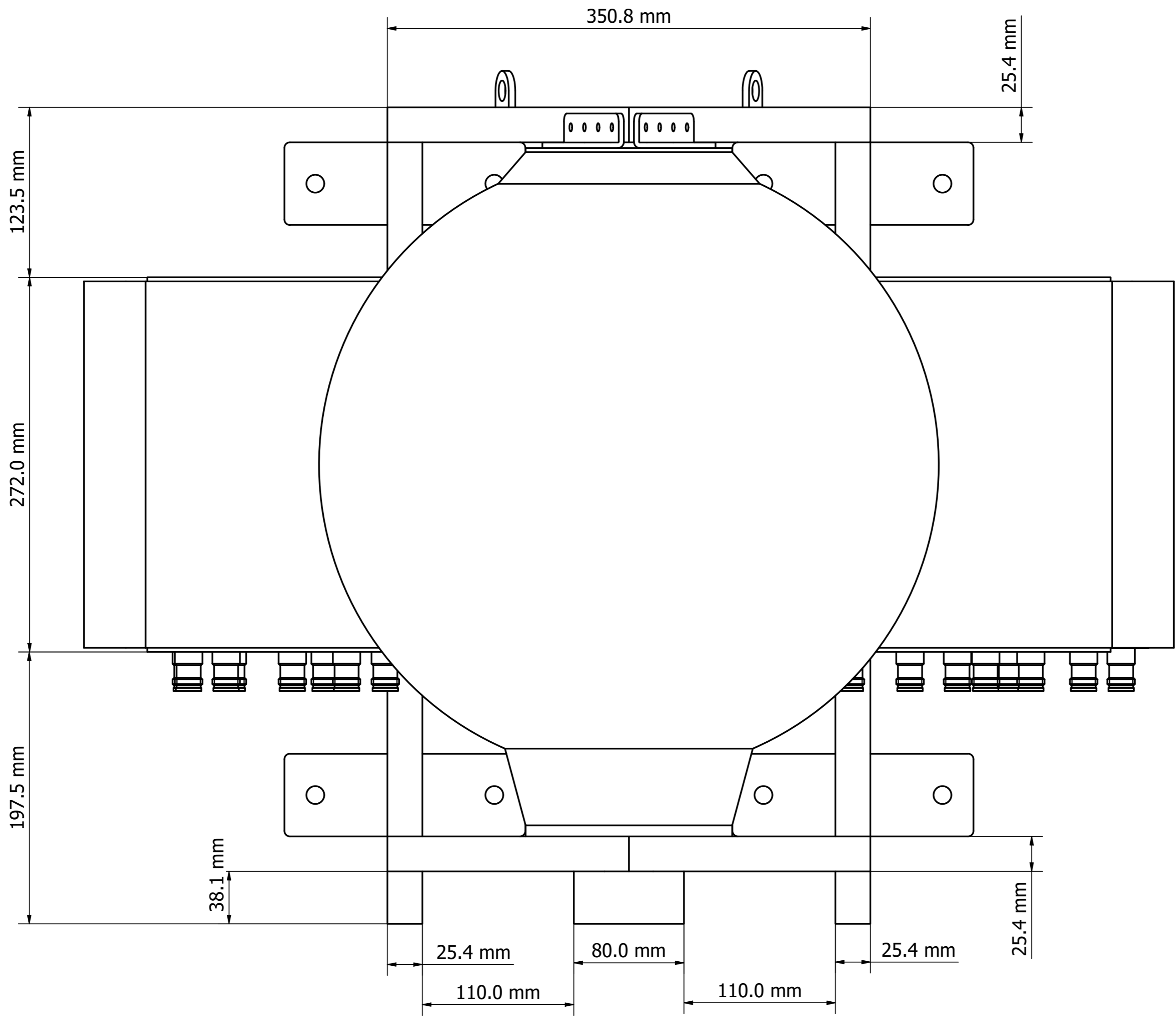

Designed by PAVEL	Drawing by LAWRENCE	Date 26/11/2021	Approved by PAVEL	Date 14/2/2022	Quantity	Material	
<b>MATSING</b> LENS TECHNOLOGY ENABLED						MS-12F45	
MS-12F45 (mm)						Revision 1.0	Sheet 1 / 6

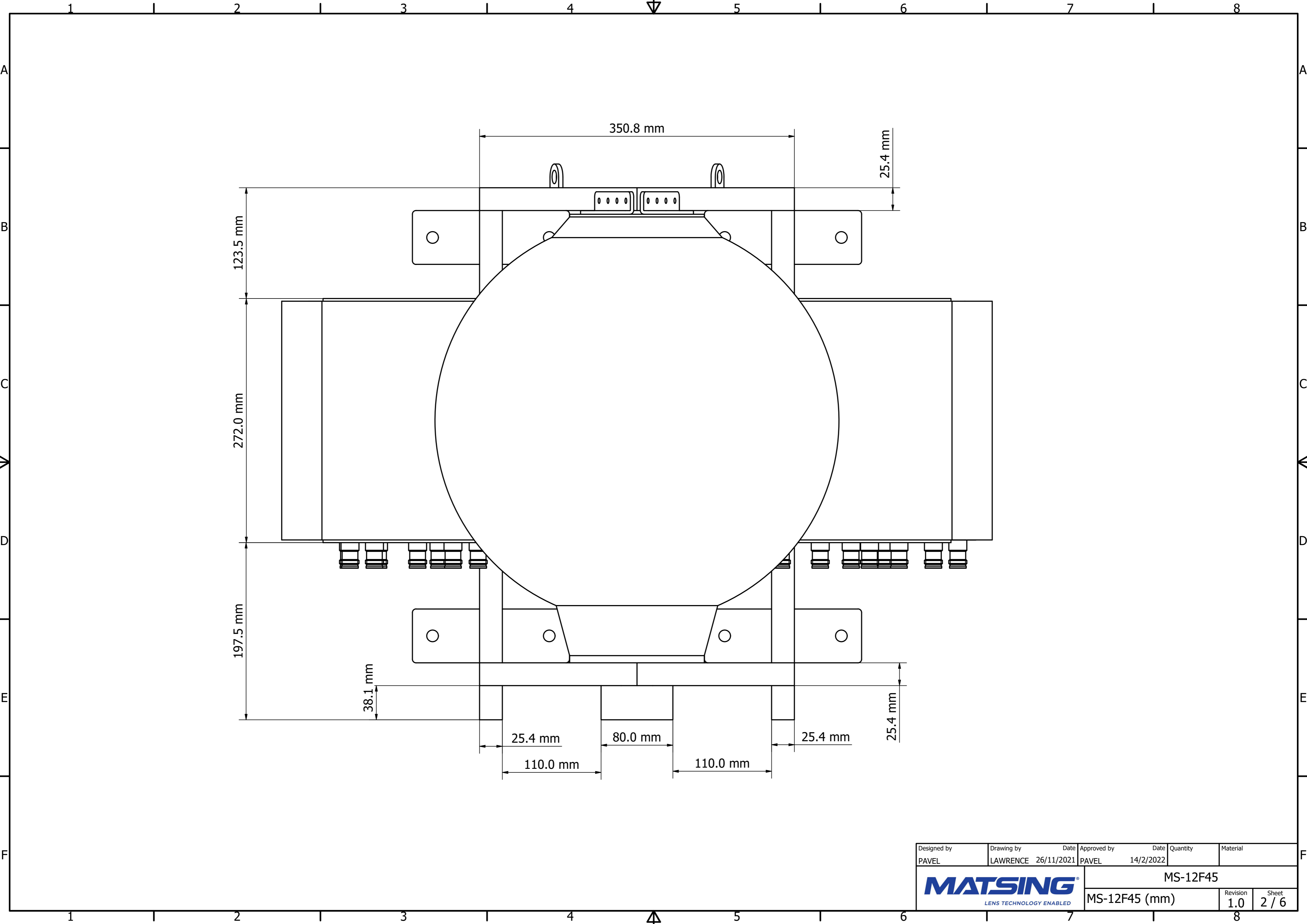

Designed by PAVEL	Drawing by LAWRENCE	Date 26/11/2021	Approved by PAVEL	Date 14/2/2022	Quantity	Material
 <b>MATSING</b> <small>LENS TECHNOLOGY ENABLED</small>						MS-12F45
						MS-12F45 (mm)

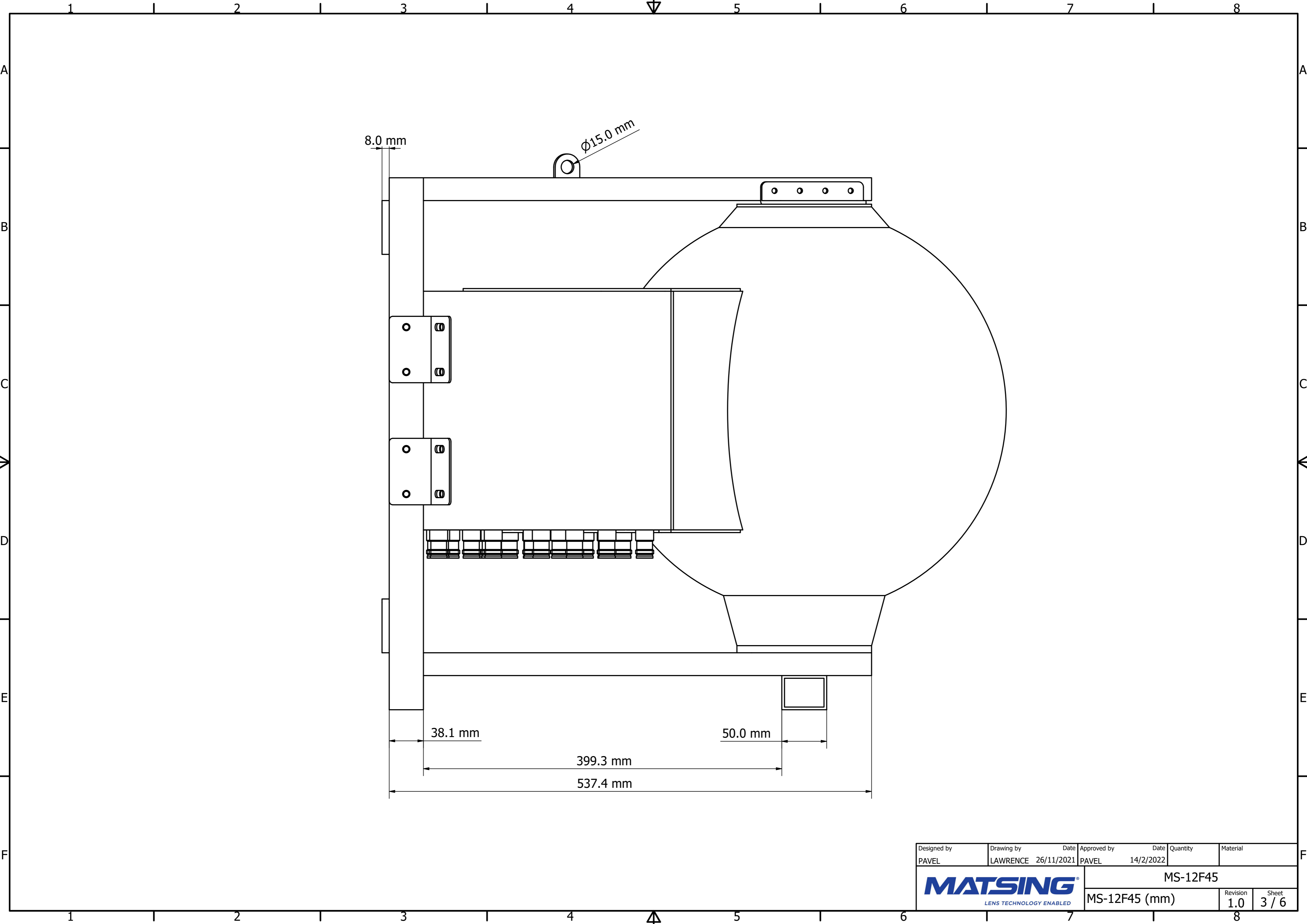

Designed by PAVEL	Drawing by LAWRENCE	Date 26/11/2021	Approved by PAVEL	Date 14/2/2022	Quantity	Material
<b>MATSING</b> LENS TECHNOLOGY ENABLED						MS-12F45
MS-12F45 (mm)					Revision 1.0	Sheet 3 / 6

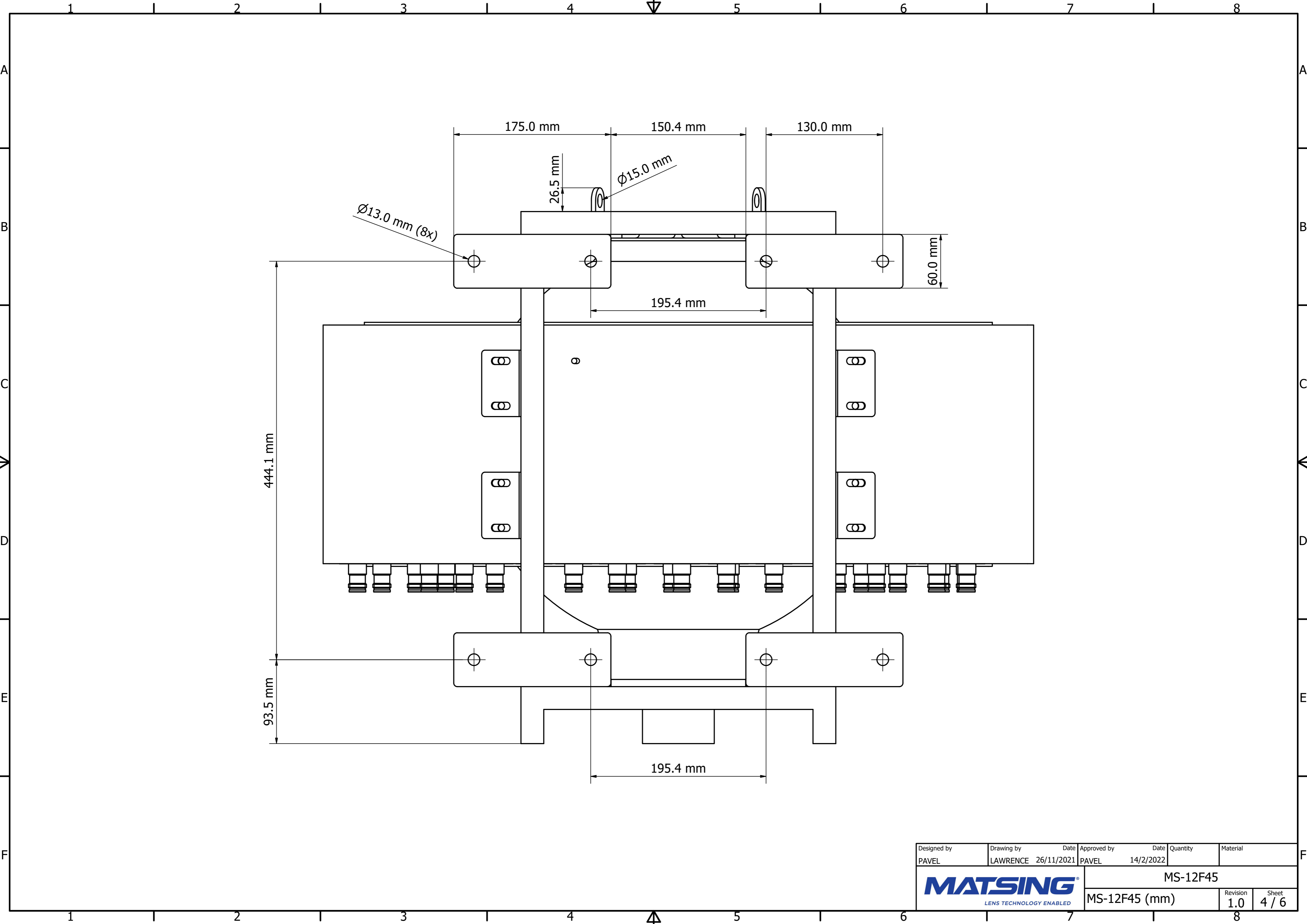

Designed by PAVEL	Drawing by LAWRENCE	Date 26/11/2021	Approved by PAVEL	Date 14/2/2022	Quantity	Material
<b>MATSING</b> LENS TECHNOLOGY ENABLED						MS-12F45
MS-12F45 (mm)					Revision 1.0	Sheet 4 / 6

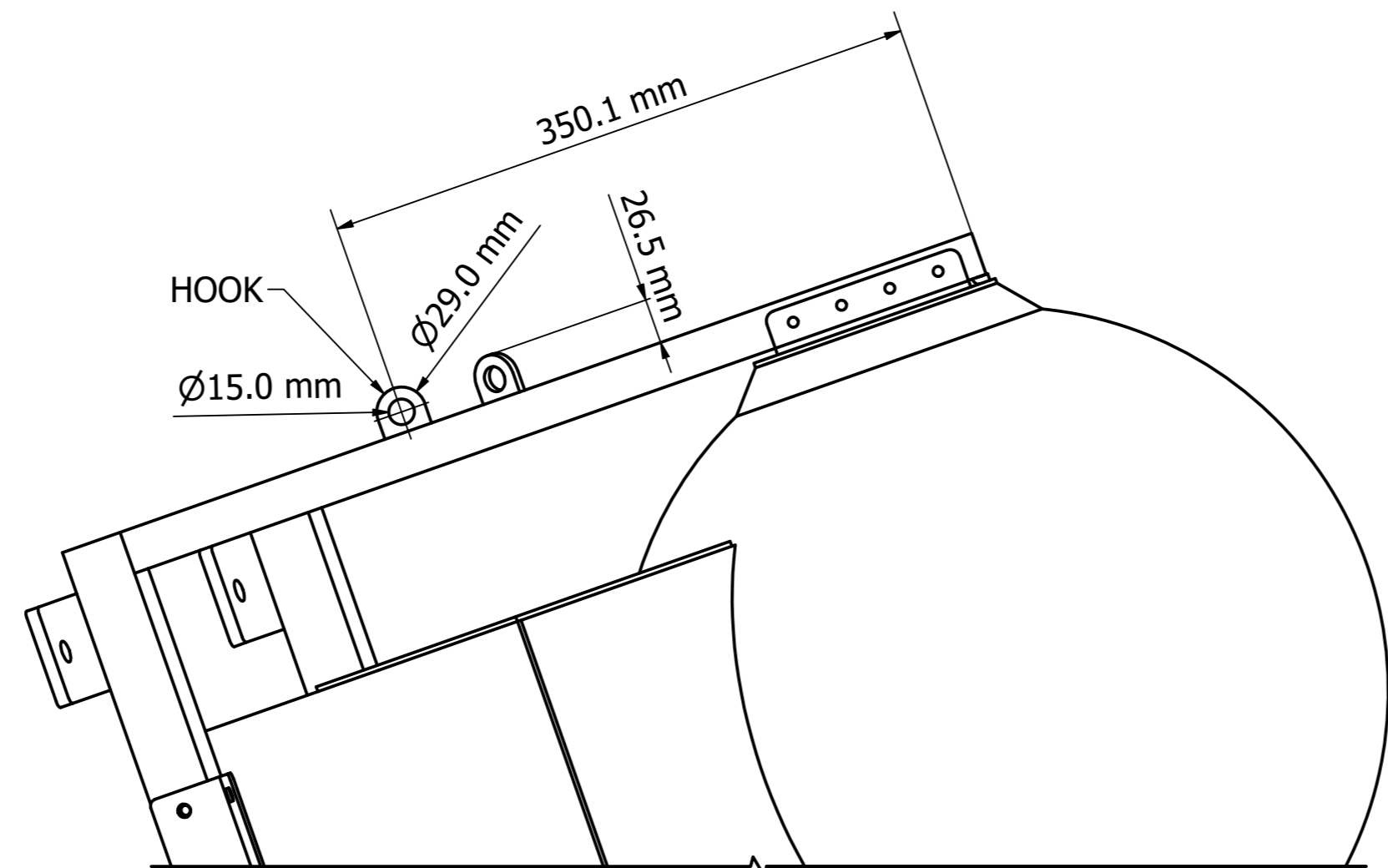

View A

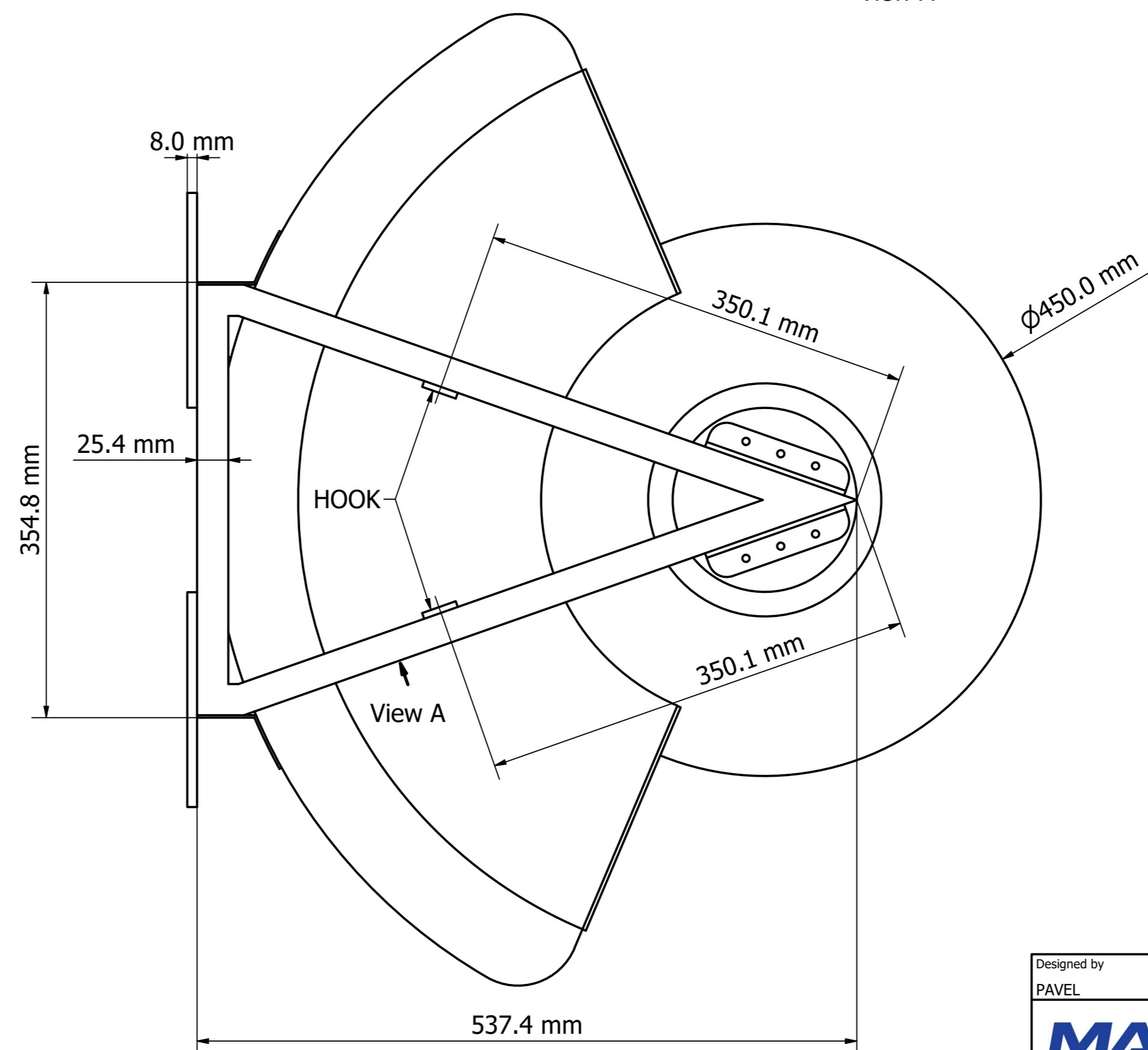

Designed by	Drawing by	Date	Approved by	Date	Quantity	Material
PAVEL	LAWRENCE	26/11/2021	PAVEL	14/2/2022		
<b>MATSING</b> LENS TECHNOLOGY ENABLED						MS-12F45
						MS-12F45 (mm)
					Revision	Sheet
					1.0	5 / 6

