

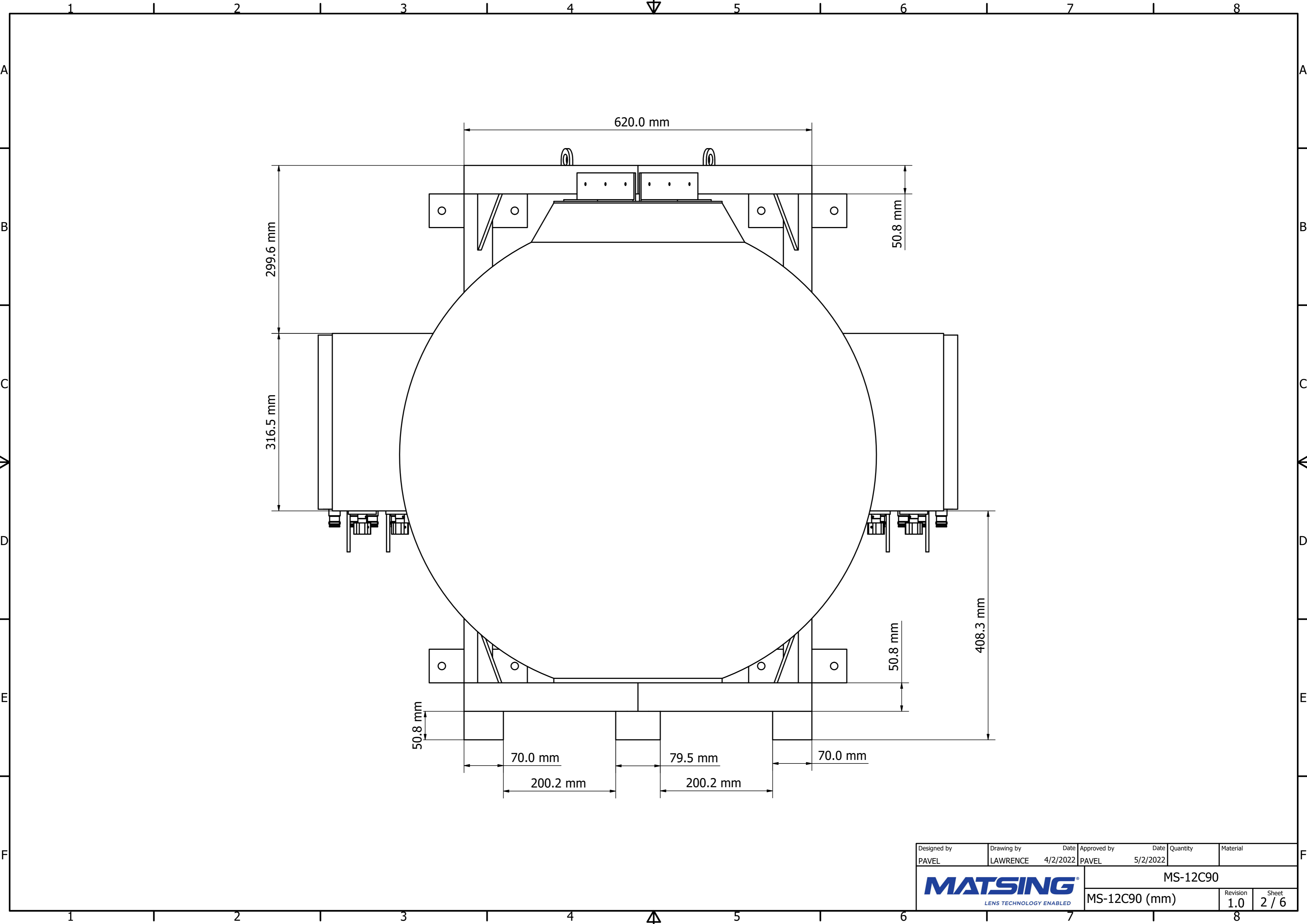

Designed by	Drawing by	Date	Approved by	Date	Quantity	Material	
PAVEL	LAWRENCE	4/2/2022	PAVEL	5/2/2022			
MATSING LENS TECHNOLOGY ENABLED						MS-12C90	
MS-12C90 (mm)						Revision 1.0	Sheet 1 / 6



Designed by PAVEL	Drawing by LAWRENCE	Date 4/2/2022	Approved by PAVEL	Date 5/2/2022	Quantity	Material
						MS-12C90
						MS-12C90 (mm)

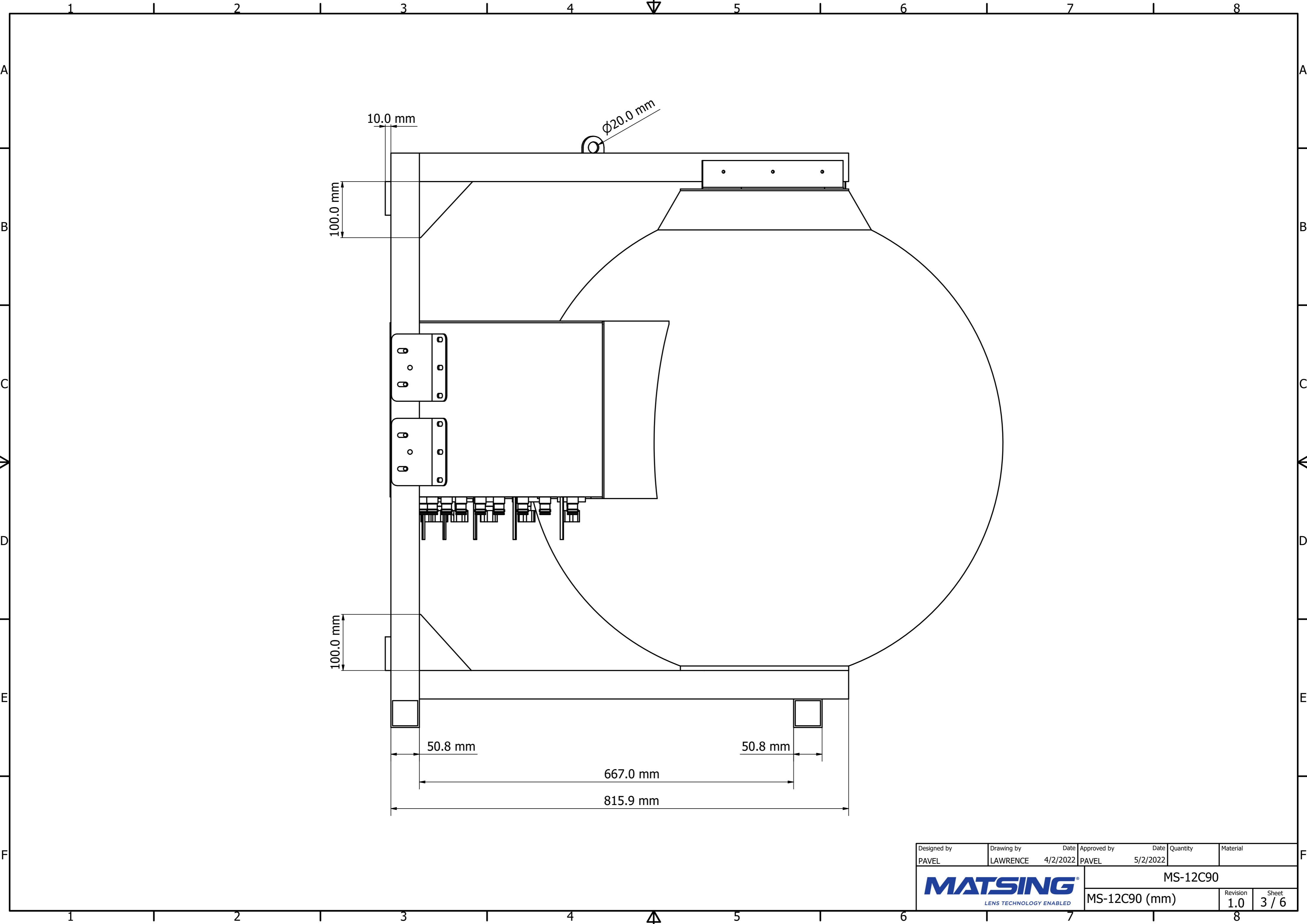

Designed by PAVEL	Drawing by LAWRENCE	Date 4/2/2022	Approved by PAVEL	Date 5/2/2022	Quantity	Material
MATSING LENS TECHNOLOGY ENABLED						MS-12C90
MS-12C90 (mm)					Revision 1.0	Sheet 3 / 6

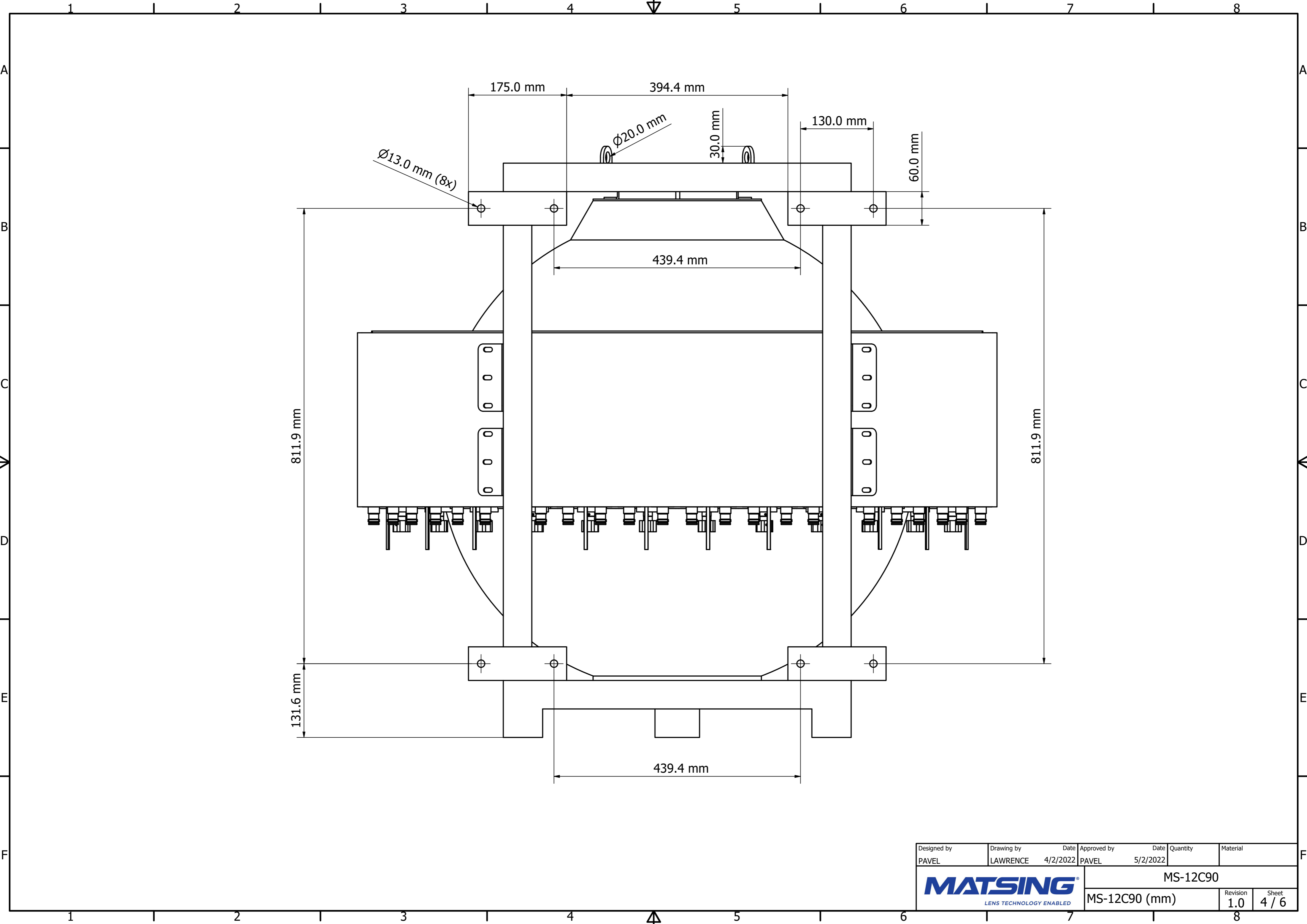

Designed by PAVEL	Drawing by LAWRENCE	Date 4/2/2022	Approved by PAVEL	Date 5/2/2022	Quantity	Material
MATSING LENS TECHNOLOGY ENABLED						MS-12C90
MS-12C90 (mm)					Revision 1.0	Sheet 4 / 6

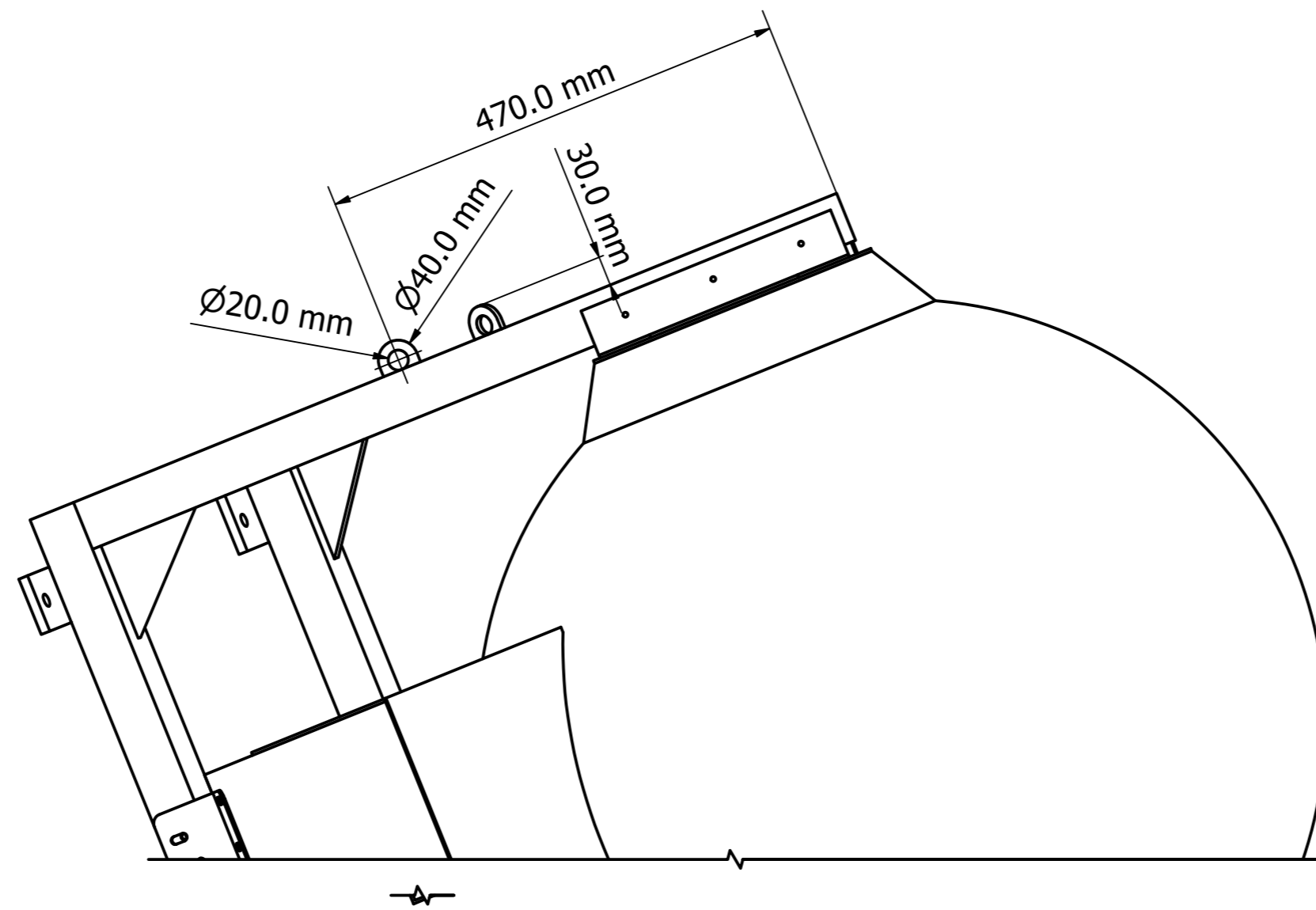

View A

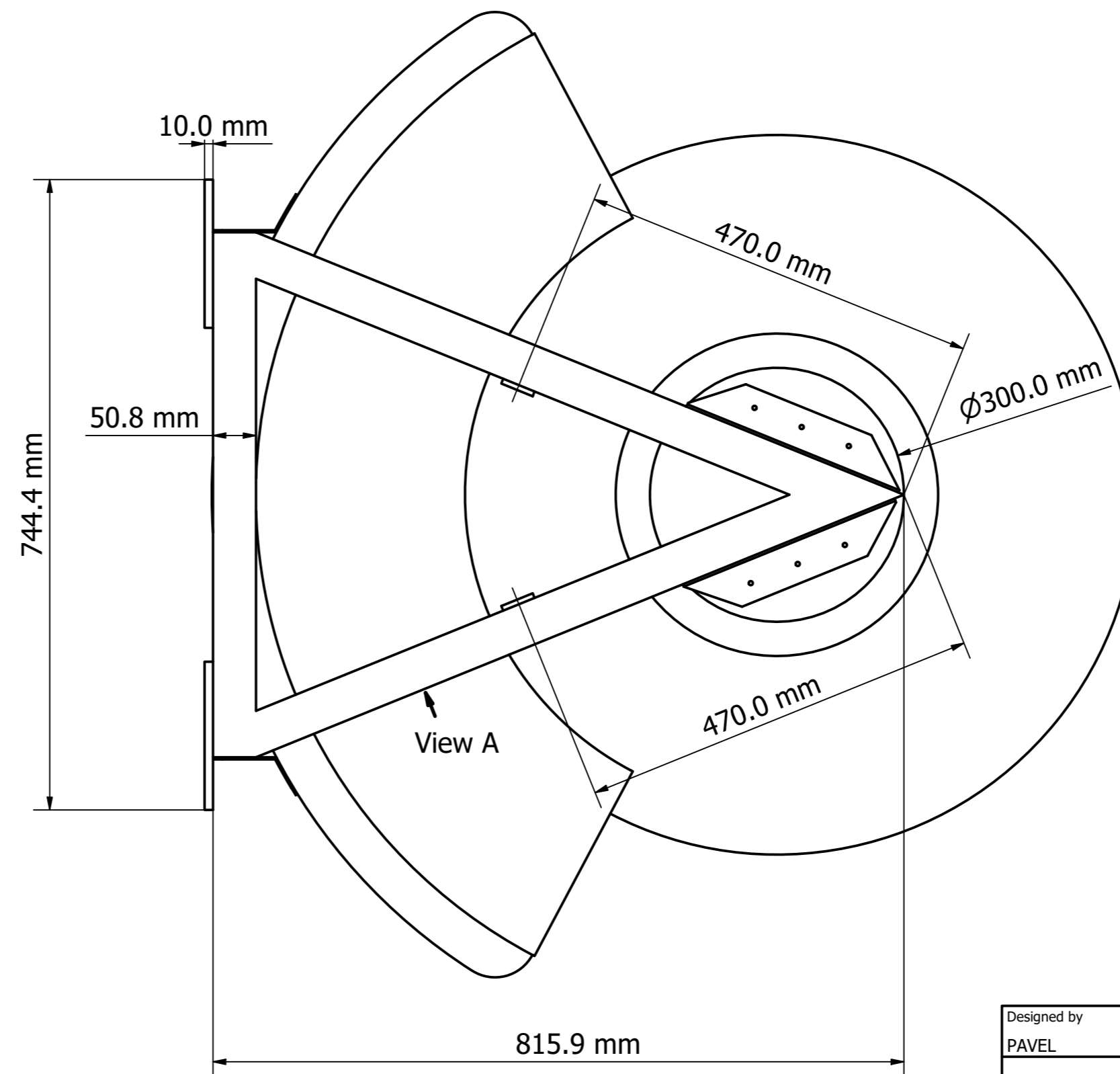

Designed by	Drawing by	Date	Approved by	Date	Quantity	Material	
PAVEL	LAWRENCE	4/2/2022	PAVEL	5/2/2022			
MATSING LENS TECHNOLOGY ENABLED						MS-12C90	
MS-12C90 (mm)						Revision 1.0	Sheet 5 / 6

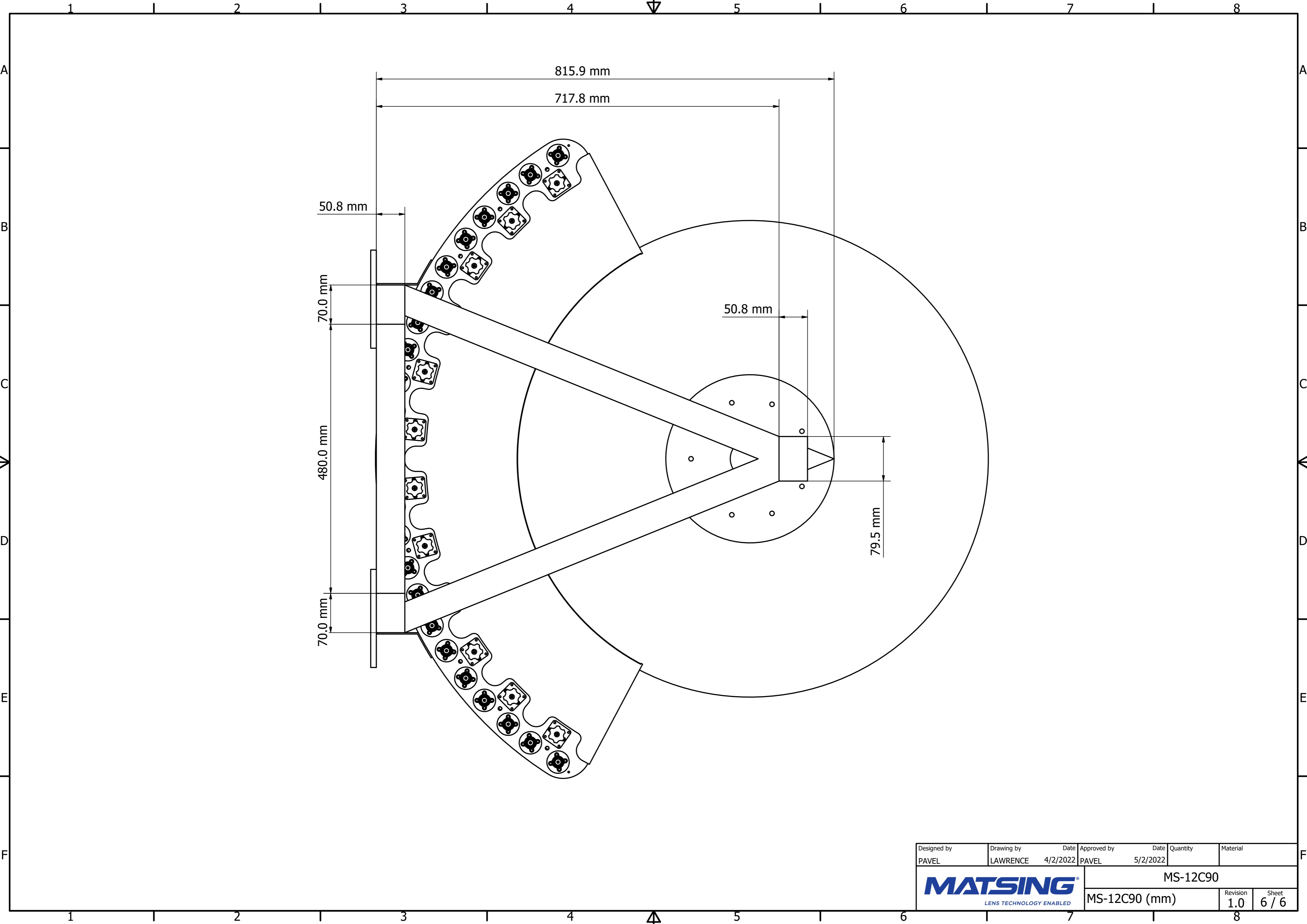

Designed by PAVEL	Drawing by LAWRENCE	Date 4/2/2022	Approved by PAVEL	Date 5/2/2022	Quantity	Material	
MATSING LENS TECHNOLOGY ENABLED						MS-12C90	
MS-12C90 (mm)						Revision 1.0	Sheet 6 / 6