

MS-MBA-4.4.2-C2-H2-L2

Lens Technology Enabled™ Multi-Beam Tri Band Base-Station Antenna utilizes a patented spherical lens design with 4 isolated C Band (3.7GHz – 4.2GHz) cross-polarized beams, 4 isolated High Band (1695MHz – 2690MHz) cross-polarized beams and 2 isolated Low Band (698MHz – 960MHz) beams, each beam has 2 ports to support 2x2 MIMO. RET for C Band & High Band Beams 0°-20°. RET for Low Band Beams 0°-40°.

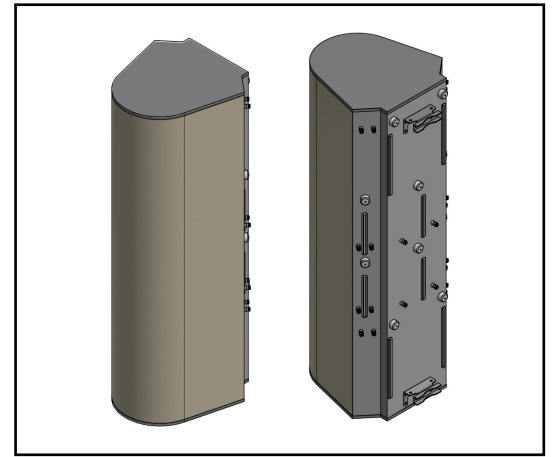

PATTERN RESULTS:

C-Band Horizontal Pattern (3.7GHz)

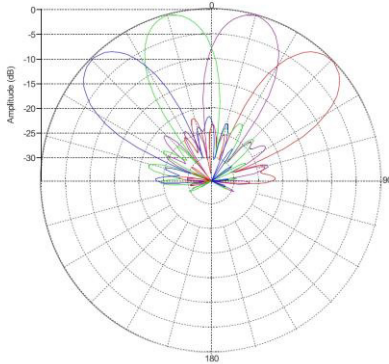

C-Band Vertical Pattern (3.7GHz) at tilt 0° and 20°

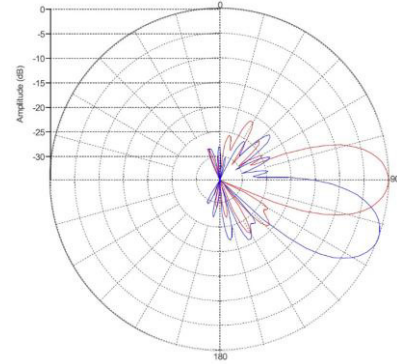

High-band Horizontal Pattern (1.92GHz)

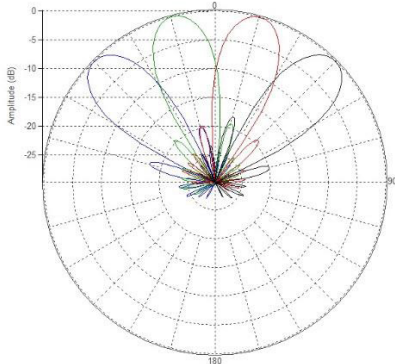

High-band Vertical Pattern (1.92GHz) at tilt 0° and 20°

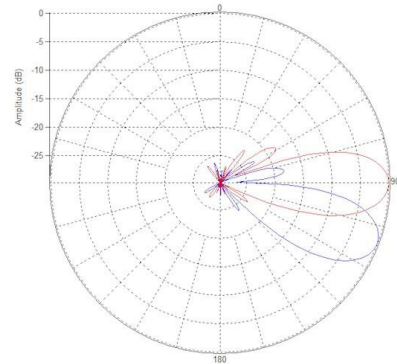

Low-band Horizontal Pattern (0.8GHz)

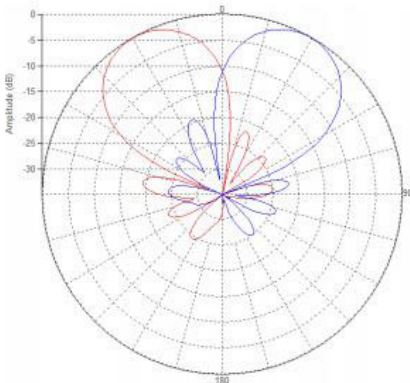

Low-band Vertical Pattern (0.8GHz) at tilt 0° and 40°

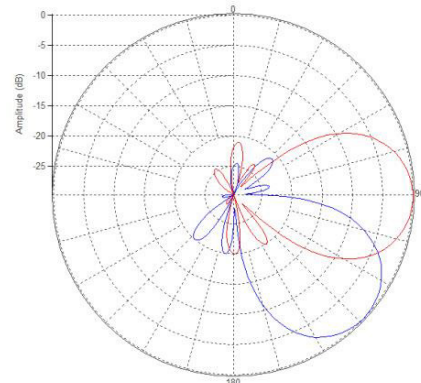

TECHNICAL SPECIFICATIONS PER BEAM

	3.7 – 4.2 GHz	1695 - 2690 MHz	698 – 960 MHz
Frequency	3.7 – 4.2 GHz	1695 - 2690 MHz	698 – 960 MHz
Gain	18dBi	19dBi	14.2dBi
VSWR	<1.5:1	<1.5:1	<1.5:1
Polarization	Dual Slant ±45°	Dual Slant ±45°	Dual Slant ±45°
Horizontal Coverage	120°	120°	120°
Horizontal Beamwidth (10dB)	34°	30°	60°
Horizontal Beamwidth (3dB)	19°	17°	34°
Vertical Beamwidth (10dB)	34°	30°	60°
Vertical Beamwidth (3dB)	19°	17°	34°
Beam Cross-over	7dB typical	10dB typical	10dB typical
Total Number of Beams	4	4	2
Number of Ports per Beam	2	2	2
Number of Ports Total	8	8	4
Tilt Per Cross-Pol; Remote Electrical Tilt (AISG 2.0)	0° to 20°	0° to 20°	0° to 40°
First Sidelobe Level	<-16dB	<-16dB	<-16dB
Front to Back Ratio	>28dB	>28dB	>28dB
Isolation Port to Port - Polarization	>28dB	>28dB	>28dB
Isolation Port to Port - Beam	>28dB	>28dB	>28dB
Power Rating	150W per port	150W per port	150W per port
Intermodulation	<-153dBc	<-153dBc	<-153dBc
Impedance	50 ohm	50 ohm	50 ohm
Connector Quantity and Type	8 x 4.3-10 female	8 x 4.3-10 female	4 x 4.3-10 female

MECHANICAL DATA

Dimensions (H x W x D)	140.9 X 61.7 X 72.1 cm 55.5 X 24.3 X 28.4 inch
Antenna Weight	47.7 kg 105.1 lbs
Radome Material	Fiber Glass
Mounting	Standard pipe mount Compatible pipe diameter: 6.1 – 11.4 cm 2.4 – 4.5 inch

ENVIRONMENTAL RATINGS

Humidity	95% RH @ +30°C
Temperature	-40°C to +70°C
Wind load Frontal	462 N @ 151km/hr 104 lbf @ 151km/hr

CONNECTOR LAYOUT:

